



Operation Manual for PAVA6500 System

Guangzhou DSPPA Audio Co., Ltd



PAVA6500
PAVA6500E
PAVA6006
PAVA6000

●	About this Manual	3
●	Overview of the System	4
●	Characteristics of the System.....	4
●	Configuration of the System	5
1.	PAVA6500/PAVA6500E (Control Host/Extended Host)	5
1.1.	Front Panel.....	6
1.2.	Rear Panel.....	10
1.3.	Technical Specification.....	15
◇	Electrical Indicators.....	15
◇	Mechanical Indicators.....	16
◇	Environment Requirements.....	16
2.	Business MIC——PAVA6006	17
1.4.	Front/Rear Panels.....	17
1.5.	Technical Specification.....	20
◇	Electrical Indicators.....	20
◇	Mechanical Indicators.....	20
◇	Environment Requirements.....	20
3.	Wiring Diagram of the System	21
4.	Routine Operation	21
4.1.	Host Lines 01-06 for Manual Playing.....	22
4.2.	Manual Playing of EVAC Voice.....	22
4.3.	Automatic Triggering of EVAC Voice	22
4.4.	PAVA6000 Operation.....	23
4.5.	Paging Operation Using Emergency Microphone	24
4.6.	Operations in PAVA6006 are as follows.....	24
●	Software Introduction (PAVA6000)	24
❖	Description of Icons in the Software.....	24
Note: HOST 01 represents the system host, namely, PAVA6500, and the extended host 1 is: HOST		
02 Initialize		25
2.	Initialization.....	26
2.1.	Computer configuration.....	26
2.2.	Installation	26
2.3.	Uninstall.....	28
2.4.	Operation	28
2.4.1.	Software Login.....	28
2.4.2.	Introduction of Control Interface.....	30
2.4.2.1.	Introduction of Menu Bar and Tools.....	30
2.4.3.	Introduction of “Current Operating Interface Selection”.....	31
2.4.3.1.	Partition Control	31
2.4.3.2.	System Equipment State (STATE).....	33
2.4.3.3.	SYSTEM CONFIGURATION	34
2.4.3.3.1.	Check the Detailed Configuration Parameters of the System Equipment	34
2.4.3.3.2.	Fire Rules.....	37

2.4.3.3.3. Grouping Configuration of the System	38
2.4.3.3.4. Configuration of Audio Priority of the System.....	39
2.4.3.4. Log Query of Equipment Modules	40
2.4.3.5. "OTHER" (Other settings).....	41
● Precautions	43

● About this Manual

❖ Objectives of this Manual

- Provide the information required for installation, configuration and operation of PAVA6500 Voice Alarm System.

❖ Target Users

- Users and Installers of PAVA6500 Voice Alarm System;

❖ Terminology

- “System Host” —— PAVA6500;
- “Extended Host” —— PAVA6500E;
- “Business MIC” —— PAVA6006;
- “Control Software” —— PAVA6000;

Note: The software functions of this system will continue to upgrade, but it will be backward compatible, so please pay an attention to the real-time information of the website of the Company.

● Overview of the System

PAVA6500 voice alarm system is the public address and voice alarm system. It has integrated with the EN60849, BS5839/8, EN54-16 and other evacuation standards. It is usually used in the small-scale systems that must meet the evacuation standards or the systems whose application can be met only when one call channel is required.

● Characteristics of the System

- ❖ **Comply with the requirements of national standard GB16806-2006 and European Voice Alarm Control and Indicating Equipment Standard EN54-16;**
- ❖ **Automatic system fault diagnosis, data backup, redundant line and record fault status (<=5000 records) are safe, stable and reliable;**
- ❖ **Compatible with the wiring standard of 3-wire and 4-wire systems;**
- ❖ **Built-in emergency voice message and tone information. The user can freely replace them according to the site environment, language and their fancies.**
- ❖ **Programmed to partitions, support manual, automatic, partition and grouping operations;**
- ❖ **Support the visual human-machine interface operation and control, support simultaneous operation and control of multi-windows human-machine interfaces. Offline operations are available after the configuration.**

● Configuration of the System

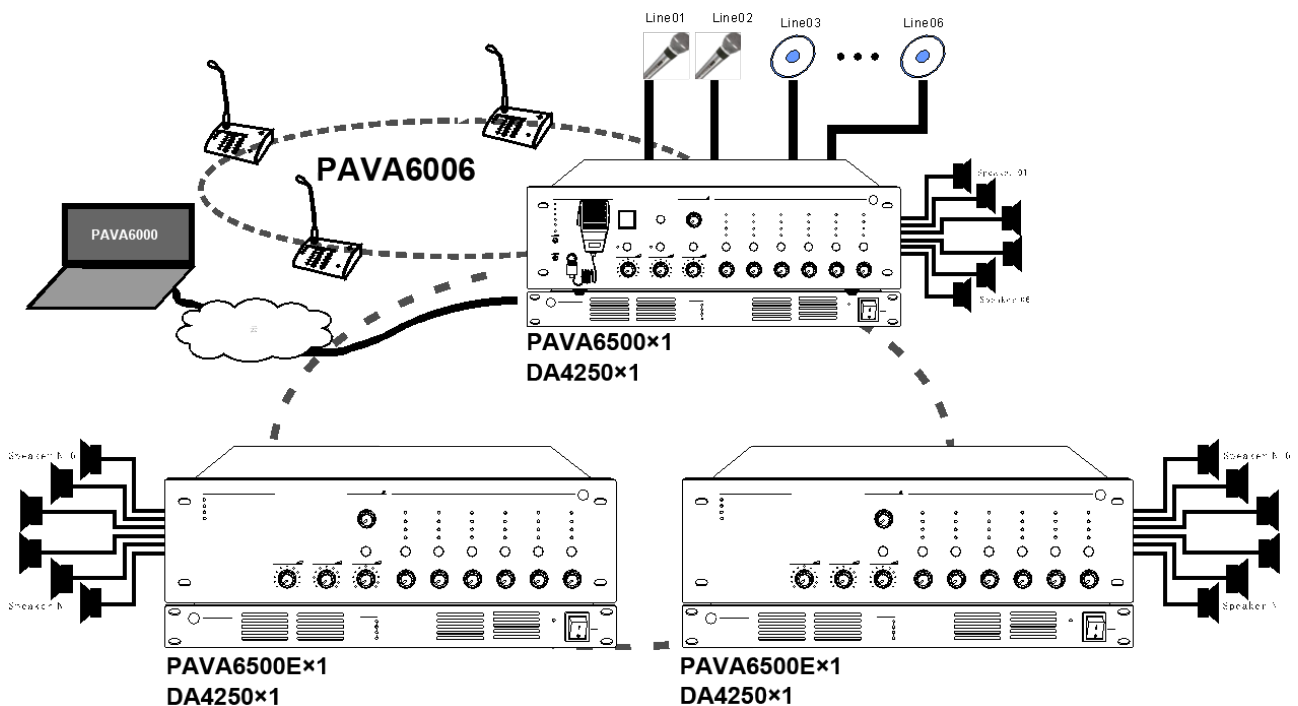

Equipment Introduction

1. PAVA6500/PAVA6500E (Control Host/Extended Host)

PAVA6500 is the core of voice alarm control of EVAC System, built-in with 240W/350W/500W digital amplifier, which not only is available for early warning and alarming(Both alarming way and voice can be achieved by way of programming), but also can realize the evacuation guidance on the site via the handheld microphone, and control the emergency calls and business broadcasting of up to 120 partitions as well as the play of background music.

- Handheld microphone is available for site evacuation in case of any emergency;
- Built-in EVAC voice message and Chimes Management for a real-time monitoring.

Notes:

1. Audio message format extension is: *.wav;
2. The message number under the directory of "evac_message/" and "alert_message/" and "prompt/" in the SD card shall be controlled within 255;

➤ Built-in 240W/350W/500W digital function amplifier, and meanwhile available to connect a backup amplifier of the same power to realize the automatic replacement;

Note: please keep pace with the actual configuration. For example, if a backup amplifier is configured by the user and no backup amplifier of the same power or above is in fact connected, in such a case, the host is unable to detect the existence of the spare power amplifier.

➤ 6 partitions; each partition can output 500W;

Note: total power of 6 partitions cannot exceed 500W;

➤ Available for external connection of 6-line inputs to play the background music;

➤ Support event linkage and partition output;

➤ up to 3000 status records of equipment modules, including power module, handheld microphone module, voice message module, power amplifier module, speaker circuit module, etc. (please consult the related descriptions in PAVA6000);

➤ Able to simultaneously connect up to 32 PAVA6006 systems with a distance of at least 600m;

➤ Support line redundant wiring between business microphone, host and extended host;

Note: total length of hand-in-hand redundant line shall be less than or equal to 600m.

1.1. Front Panel

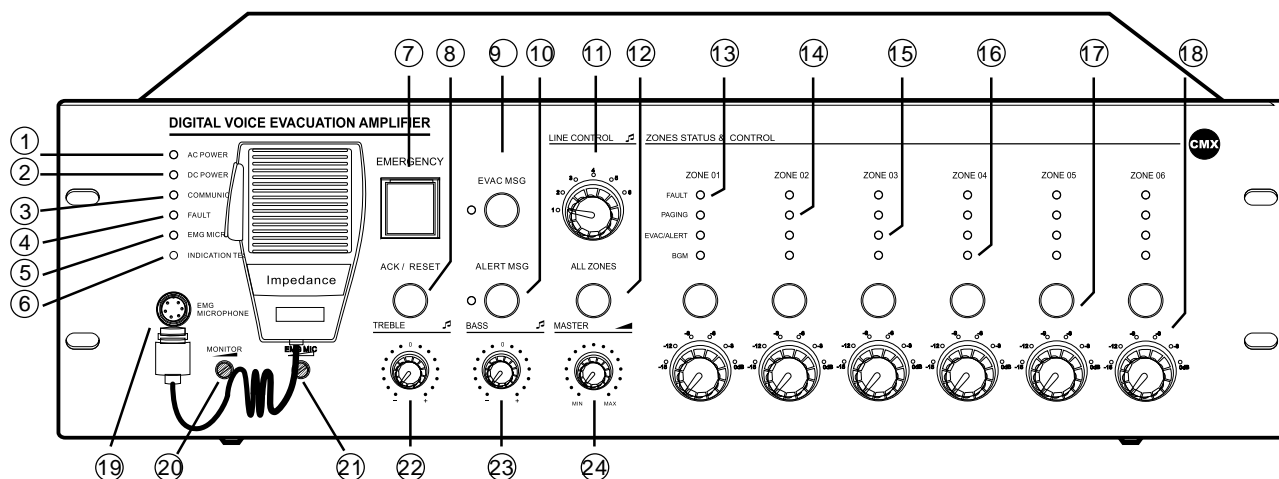

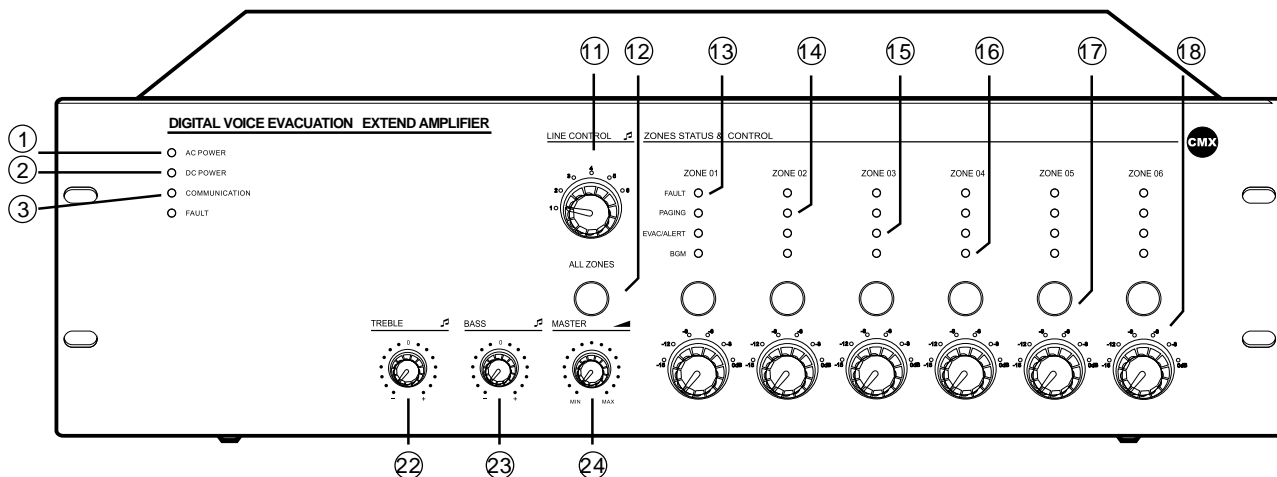

1 — Main power indicator of the host:

- ◆ Green – indicating that the current host AC power supply is normal;
- ◆ Yellow – indicating that the current host AC power supply is in trouble;

2 — DC24V Backup Power Indicator of the Host

- ◆ Green – Indicating that the current host backup power supply is normal;
- ◆ Die-out (OFF) – Indicating that the current host backup power supply is not configured;
- ◆ Yellow – indicating that the current host backup power supply is in trouble.



Note: , in the left chart (host is the second bit in PAVA6500 and host is the sixth bit in PAVA6500E), pull-up indicates that the system is configured and pull-down indicates that the system is not configured.

3 — Connection Status Indicator of Host/Extended Host

- ◆ Yellow – indicating that the current extended host does not establish the logical or physical connection with the host;
- ◆ Die-out (OFF) – indicating that the current host does not establish the logical or physical connection with PAVA6000;
- ◆ Green – Indicating that the current equipment is connected normally.

4 — Equipment Status Indicator

- ◆ Die-out (OFF) – Various modules of the system work normally (it will also die out if the total detection switch is prohibited, but this does not indicate that all modules are normal);
- ◆ Yellow – System is in trouble (if the system is not failed but this indicator light still flashes, please press the Key “ACK/RESET”).

5 — Status Indicator

- ◆ Yellow – Indicating there is a fault when the handheld microphone is lost or failed;
- ◆ Green – Indicating that the microphone is operating;

- ◆ Die-out – Indicating that the handheld microphone is normal but it does not work.

6 — System Equipment LED Indicator Test (mainly test the LED of host/extended host and business microphone panel)

Note: if there is an extended host or business microphone in the system configuration, it will enter LED test model after pressing this key.

7 — System Work Mode Indicator

- ◆ Red Flash – Indicating the current system is in an emergency mode;
- ◆ Die-out – Indicating the current system is in a normal mode;
- ◆ Two Ways to Enter the Emergency Mode:

Manual Mode – under the normal mode, the red indicator light flashes after pressing this key, which indicates that the system manually enters the emergency mode;

Automatic Mode – under the normal mode, after detecting the effective triggering signals at the rear row “TriggerInputs” of the host or extended host, this indicator light will also flash, which indicates that the system works in the emergency mode.

- ◆ Two ways to exit the Emergency Mode:

Manual Mode – Under the emergency mode, the system exits from the emergency mode by pressing this key, and meanwhile it stops the playing of EVAC voice message and the partition output;

Automatic Mode – under the emergency mode, it can exit from the emergency mode by way of direct short circuit at 2 input ports of rear row “System Link Control” port 3, and meanwhile, it stops the playing of EVAC voice message and the partition output.

Note: no matter whether it is a manual entry (exit) or automatic entry (exit), its execution time and way can be checked in the LOG of PAVA6000.

8 — Multi-purpose Reset Key (ACK/RESET):

- ◆ Answering System Status -
 - a. if various system modules work normally or when the diagnosis of system modules is abnormal but “FAULT” indicator light does not flash, no treatment is made to the equipment after pressing this key;
 - b. If the diagnosis of system modules is abnormal and “FAULT” indicator light intermittently flashes, after pressing this key, “FAULT” indicator light is ON and does not flash any longer, which indicates its fault status, and the buzzer stops until the FAULT LED light re-flashes after abnormality is detected in new module and the buzzer is started to prompt the user;
 - c. When there is any output from the current partitions, press this key to close the current audio output and quickly end the broadcasting.

9 /10 — EVAC Voice Message Status Indicator

- ◆ Green – “EVAC MSG/ALERT MSG” voice message is broadcasting;
- ◆ Yellow - “EVAC MSG/ALERT MSG” voice message is lost or SD Card is lost;
- ◆ Die-out (OFF) - “EVAC MSG/ALERT MSG” voice message is normal.

Note:

1. “EVAC Voice Message” means the general designation of EVAC voice and ALERT Voice;
2. If any user wants to manually play the EVAC voice message, he/she shall enter the emergency mode and then press the voice message key;
3. In the system default, the priority of “EVAC” Voice is higher than that of “ALERT” Voice. Of course, it can be altered through the priority configuration of PAVA6000. If it is not a specific application need, please do not change it.

○,11 — Line Output Selector Switch

- ◆ Mainly used to select the output audio of current partition;

Note: the current selection of the user can be checked via the interface of PAVA6000. When it is required to change different audio output, it can only be selected from the panel.

○,12 — ON/OFF Selection of Partitions (Partitions)

- ◆ If the current partitions are closed, they shall be all opened (ON); if the current partitions are all opened, they shall all be closed (OFF).

○,13 — Speaker Partition Status Indicator

- ◆ Yellow – indicating there is a change of impedance of Speaker A or Speaker B or the current partitions A or B, which may cause the open circuit or short circuit;
- ◆ Die-out (OFF) – indicating that the change of speaker circuit impedance of current partitions is within the impedance range during the modeling of speaker partitions;

Note: it is required to conduct an impedance method calibration to obtain the impedance value of current speaker circuit before the host or extended host is wired into the system. The method is as follows:

Pull down the seventh bit of rear row ID switch of the host until you hear the alternate beeps of the buzzer or see the flash of FAULT Indicator Light on the panel before pulling up the seventh ID switch. When the impedance variation of speaker circuit exceeds the $\pm 10\text{-}30\%$ of impedance value acquired by the current host or extended host, the current variation will then be recorded and it will be informed to the user in the form of sound and light. The detection sensitivity of partitions /partitions is equal to or greater than 20W.

14 — Partition PTT or Remote Business Microphone Paging Indication

Note: for a paging service, the user can manually close the partitions that are not call or increase the new partitions.

15 — Indication that the Partition is Broadcasting “EVAC” Voice Message

Note: the user can manually close the partitions that are not call or increase the new partitions.

16 — Indication that the Partition is Broadcasting the Background Music

Tip: it is required to select the audio before selecting the output partitions while manually playing the voice message. For example, if you want to output the audio of Line 3 to the Partition 3, you can select the partition before selecting the audio, or you can select the audio before selecting the partition. Of course, the final outcomes are the same. In general, it is habitual to select the partition before selecting the audio. In such a way, various partitions will output the audio simultaneously, and in addition, it can be operated in the partition control interface of PAVA6000.

17 — Partition Selection Key

Notes:

1. If one of the current partition output indicator lights “PAGING”, “EVAC/ALERTA” or “BGM” is ON, it will close the output of current partition by pressing this key;
2. If none of the current partition output indicator lights “PAGING”, “EVAC/ALERTA” or “BGM” is ON, one of them will be ON by pressing this key (The corresponding LED light is ON according to the current output audio).

18 — Partition Output Level Attenuation

Note: there are six levels in all, with the maximum attenuation of up to -15dB.

○,19 — Air Outlet

Note: it is used mainly to connect and fix the handheld microphone.

○,20 — Adjustment of monitoring speaker output volume

Note: the host can monitor the current output audio, which can be adjusted by this knob.

○,21 — Adjustment of Handheld Microphone Output Sensitivity

○,22 — Adjustment of Handheld Microphone Sensitivity

◆ Adjust the handheld microphone output sensitivity.

○,22 / ○,23 — Adjustment of Audio Volume

○,24 — Adjustment of Total Output Volume of Partitions

1.2. Rear Panel

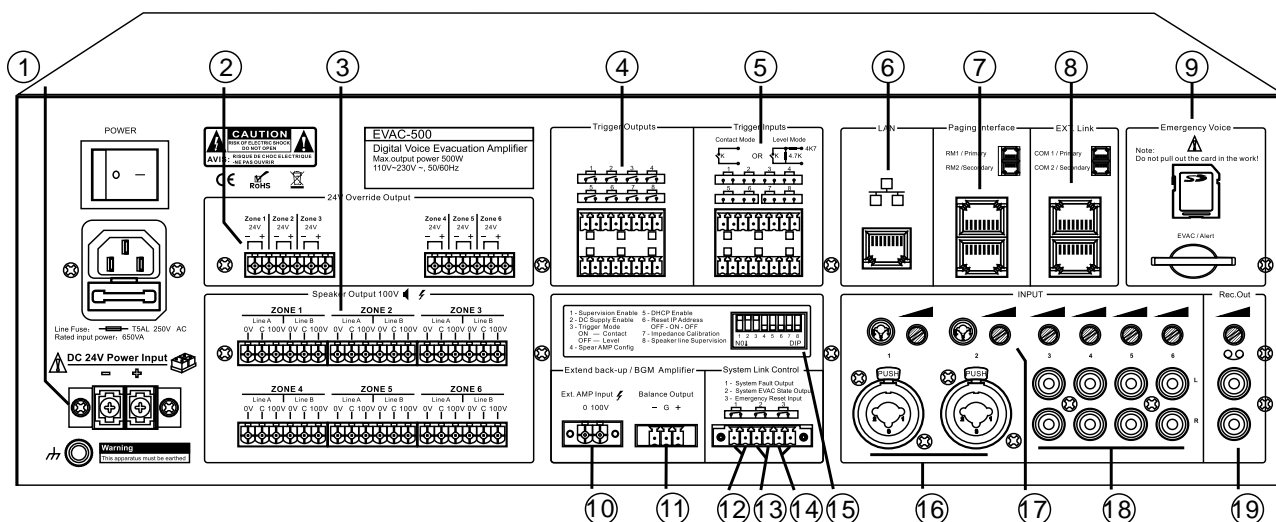

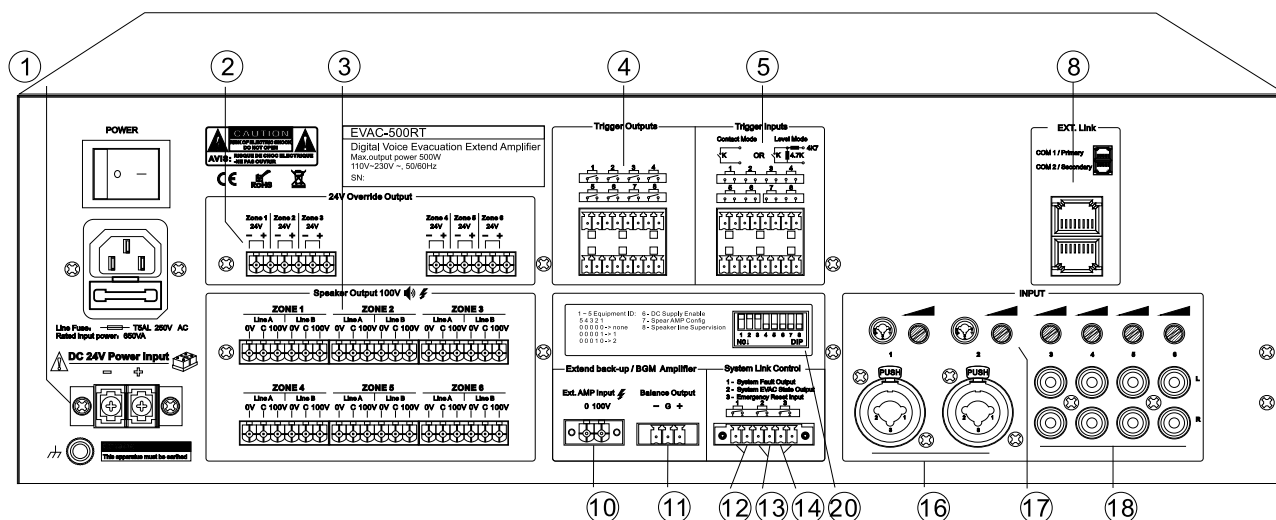

○,1 — DC24V DC Power Input Jack (Interface)

- ◆ The DC24V power supply to be connected can be the sealed lead-acid batteries, UPS or their similar products.

Notes:

1. If an EN standard shall be adopted, please confirm that the power supply complies with the Standard EN54-4.
2. Please confirm that DC24V power supply can provide the minimum operating current for the rated output of PAVA6500 (take the combination of PAVA6500 with the sealed lead-acid battery for example: if it works in the full load, the output current provided shall not be less than 27A, namely, power capacity shall not be less than 27Ah, and the operating time is: <full load operation *27Ah*1.2> hour).

○,2 — 6 DC24V Output Interfaces

- ◆ Connect four-wire audio control system;
- ◆ The rated output current is 0.2A for each line.

Note: the total output power of the six lines may not be greater than 28W.

○,3 — 6 Speaker A&B Circuit Output Interfaces

- ◆ Connect the constant pressure speaker or 3-wire audio control system;
- ◆ Output voltage is 0-100V.

Note: please make at least one modeling of the speaker circuit after completing the wiring. It will be OK to suspend the partition that is not connected with the speaker. Of course, its output can also be prohibited in PAVA6000 (the related operations refer to the related chapters of PAVA6000).

○,4 — 8 Programmable Linkage Relay Output Interfaces

- ◆ Under the normal status, Output 2 is normally open. Its output status can be decided by the input status of "5" in PAVA6000, and its output status can be controlled manually in PAVA6000.

Notes: when the linkage relay is controlled by multiple input statuses, its outputs belong to an adding relationship. For example, the contact 1 of "5" is configured to open the output interface 1, and it does not select the output interface 2. However, contact 4 of "5" has selected the output interface 2, but it does not select the output interface 1. The output interfaces are 1 and 2 when they occur simultaneously.

○,5 — 8 Programmable Input Contact Interfaces

- ◆ Under the normal status, it will be OK to maintain the normal opening. When a short circuit status is detected, it will trigger a preset processing event (the preset processing event of the contact refers to the PAVA6000).

○,6 — Ethernet Interface

- ◆ Mainly used to connect the PAVA6000.

Notes:

- 1) The default IP address of the equipment is: 192.168.1.168 and the communication port number is 16888.
- 2) If you forget it after the modification through PAVA6000, you can restore the default IP address by pulling off and then pulling on the sixth bit of "15" (please refer to the related chapters of PAVA6000).
- 3) Of course, if you do not want to use this default IP address, please pull on the fifth bit of "15" to open DHCP function and determine your network router has opened this DHCP function.
- 4) Support the computer to directly connect PAVA6000 device and automatically recognize the crossover and straight-through network. Of course, in order to unify the network cables of five categories of the system, they can all consult the TIE/EIA-568B standards, including the connection of PAVA6500E with PAVA6006.

○,7 — Main/Backup Interfaces of Business Microphone

- ◆ Used to connect PAVA6006;
- ◆ Support the closed and star-shape connection (shown below) and the software automatic recognition.

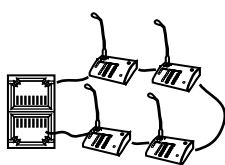

Closed or Loop Connection

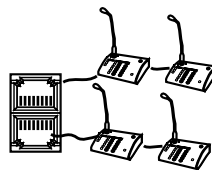

Star Connection

○,8 — Main/Backup Interfaces of Extended Host

- ◆ used to connect PAVA6500E;
- ◆ Support the closed and star-shape connection (refer to the above "7") and the software automatic recognition.

○,9 — SD Card

- ◆ Real-time detection of equipment or devices;
- ◆ The maximum capacity acquired upon the test is 32G (please format it with FAT file format);
- ◆ It is prohibited to pull out this card during the operation, because it may lead to the missing of important logs and important references of the equipment modules;

Note: File memory way in SD card;

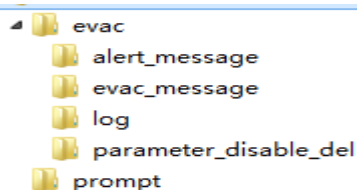

- 1) The root directory has two folders: EVAC-related message and chimes message.
- 2) The voice file in the “alert_message” and “evac_message” in the EVAC folder is defaulted as one audio file respectively while they are delivered from the factory. The user can add or delete it according to the actual needs, and the host will detect it in a real-time manner; the log message of current system modules is stored in the LOG folder, and it can be classified and checked or stored as the spreadsheet file via the PAVA6500 (Please refer to PAVA6000);
- 3) The bell voices before and after the paging of the user are stored in “Prompt” Folder, namely, the prompt tone. The user can configure different bell tone for each PAVA6006 according to the actual needs. What’s different from the EVAC voice message is that the bell message of this file will not be detected in a real-time manner and it can be read only once. No file or file damage may cause no output of bell tone during the paging process. The fault of the device will not be reported and no record will be made.
- 4) After the folder in the SD card is formatted, the host will automatically build the corresponding folder. However, the EVAC voice message and bell tone will not be automatically saved and restored, and the user shall pay attention to the backup measures to avoid the loss of message while replacing and formatting the SD card.
- 5) The number of three audio files stored in the folder shall not exceed 255. When it exceeds this number, only 255 audios are valid.

○,10 / ○,11 — **Backup Power Amplifier Interface**

- ◆ “10” power signal inputs;
- ◆ “11” audio signal output. Attention shall be paid to that it is a balanced output herein.

○,12 — **Relay Fault Status Output Interface of the System**

- ◆ In case of any fault for the system, this output interface is disconnected and conversely it is closed.

○,13 — **Relay Fault Output Interface for System Operation Status**

- ◆ When the system works in a fire status, this output interface is closed and otherwise it is disconnected.

○,14 — **Fire Reset Input Interface (greater than or equal to 0.5S relay short-circuit input, used to connect CIE device and realize the on-line control)**

- ◆ When the current equipment works in a fire mode, reset it to switch into a normal mode.
- ◆ When it is operated in a normal mode, it is not processed and ignored.

○,15 — **Host Module Configuration Switch (UP means “ENABLE” and DOWN means “DISABLED”)**

- ◆ “1” represents the total detection ID of system equipment, and when it is in “ENABLE”, it means that the user allows the equipment to monitor the operating status of various modules, and otherwise, it is “DISABLED”;
- ◆ “2” represents DC24V power supply configuration ID. When it is in “ENABLE”, it means that the system is provided with the DC24V power supply, and the user is required to connect the 24VDC power supply at “1” and otherwise, it is “DISABLED”; it will be OK to suspend the DC24V wiring ports;

- ◆ "3" represents the trigger mode configuration ID. When it is in "ENABLE", it is triggered by using the relay short circuit. "DISABLED" means the triggering by way of level.
- ◆ "4" represents the configuration ID of backup amplifier. "ENABLE" refers to the configured backup amplifier and "DISABLED" refers to the backup amplifier not configured;
- ◆ "5" refers to selection mode of host IP address. "ENABLE" means the IP address of host will use the IP address automatically allocated by the router, and "DISABLED" means that the host will use the static IP address;
- ◆ Consult the above "6 – Ethernet Port";
- ◆ "6" means to reset the host IP address to its default value: IP address is 192.168.1.168, and port number is 16888.
- ◆ "7" represents the speaker circuit impedance calibration ID (refer to front panel "13 – speaker partition status indicator"). Please ensure that the current partitions are all closed while calibrating the modeling;
- ◆ "8" represents the ENABLE ID of speaker circuit impedance test. "ENABLE" means to start the speaker circuit impedance test, and conversely, close the speaker circuit impedance test (refer to "13 – speaker partition status indicator").

○,16 — MIC or Line Input Interface

- ◆ Connect MIC or line audio input signals.

○,17 — Adjustment of MIC/Line Input Audio Sensitivity, to be operated in combination with "16,18 and 19"

○,18 — Line Input Interface, to be Operated in combination with "17"

○,19 — Host Output Audio Interface

- ◆ This interface will output the audio of current amplifier.

Please guarantee the input audio volume to make sure that the signal is not too small or distorted. Please refer to the parameter description of the whole machine.

○,20 — Module Configuration Switch of Extended Host (UP means "ENABLE" and DOWN means "DISABLED")

- ◆ Bits "1-5" represent the equipment online ID;
- ◆ Bit "6" represents DC power supply configuration. "ENABLE" means it will be configured and "DISABLED" means it will not be configured;
- ◆ Bit "7" represents the configuration of backup amplifier. "ENABLE" means it will be configured and "DISABLED" means it will not be configured;
- ◆ Bit "8" represents speaker circuit monitoring switch. "ENABLE" means the ON and "DISABLED" means the OFF.

1.3. Technical Specification

✧ Electrical Indicators

AC Power Supply

Voltage: AC 250V, 50/60Hz

Power consumption: $\leq 650W$

Max. Current: $< 3A$

Fuse rating: 250V/5A, slow type

DC Power Supply

Voltage: 24V DC, 20V ~ 27.5V

Max. Current: $< 27A$

Emergency Microphone

Sensitivity: 5mV

Impedance: 600 Ω

Caron Input

Distortion: $< 1\%$ (Rated output power), 1kHz

Sensitivity: 775mV

Impedance: 10k Ω

Signal-Noise Ratio (SNR): $> 70dB$

Line Input

Distortion: $< 1\%$ (Rated output power), 1kHz

Sensitivity: 775mV

Impedance: 10k Ω

Signal-noise ratio: $> 70dB$

Audio Output

Distortion: $< 1\%$ (Rated output power), 1kHz

Sensitivity: 0dBmV

Signal-noise ratio: $> 70dB$

System Connection Control Contact Output/Input (I/O)

System fault relay output: Short circuit, no voltage

Operating status linkage relay output: Short circuit, no voltage

Fire reset input: Short circuit, $t \geq 0.5S$, no voltage

8-line relay programmable output: Short circuit, no voltage

8-line programmable trigger way input:

Level Mode: up to 3.3V

Short-circuit mode: no voltage, short-circuit.

Voice Message

Data format: WAV

Memory type: SD card

Message number: 255*3

Retention: >10 years

Log Information

Data format: HEX

Memory type: Nand Flash

Message Number: 1000

Retention: >10years

✧ **Mechanical Indicators**

Size (length x width x depth) 484* 132* 449 mm (3U)

Net Weight: 11.5kg or so

Installation: Desktop or 19inch rack

Color: Black

✧ **Environment Requirements**

Operating Temperature: +5 °C ~ +40°C

Storage Temperature: -20 °C ~ +70°C

Relative Humidity: < 95%

2. Business MIC——PAVA6006

PAVA6006 is used for the remote control of EVAC system and allows the user to page the partitions via the remote control manner. It supports 12 partitions and 12 grouped programmable control and supports the redundant cabling.

- Partition/grouping selection in a key. It is easy to operate and it is intuitive and clear;
- Key mode and PTT mode for paging can be configured;
- Paging priority can be configured;
- Support 24V phantom power supply. It is not necessary to provide the external power supply adapter.
- use the balanced transmission to extend the transmission distance $\leq 600\text{m}$;
- Support the redundant cabling of the line.



1.4. Front/Rear Panels

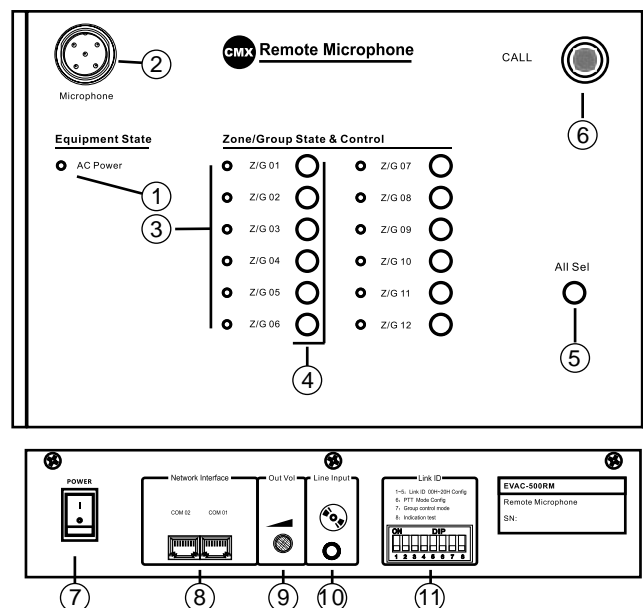

○,1 —— Power Indicator and Device “Busy” Status Indicator

- ◆ Green – Phantom power supply is normal;
- ◆ Red flash – the device is busy, please wait
- ◆ Die-out – power supply is abnormal.

Notes:

1. If the red indicator light has been flashing, please check whether the device's ID is configured normally or whether it is configured;
2. If it is green and there is no answer after pressing this key, please check whether "8" online interface is in a good contact;
3. If all LED lights flash green on the panel, please check the system configuration via the PAVA6000. If the configuration is correct, please reset this device.

○,2 — Microphone Bar

- ◆ Paging is allowed or available when the red LED light of microphone bar is ON.

Remarks: **Red LED Light** → 

○,3 — Selection of Partitions and Operating Status Indicator

- ◆ Always ON – indicating that the current partition is in a operating state;
- ◆ Flashing – indicating that its user currently selects this partition;
- ◆ Die-out – indicating that this partition does not work currently and in a ready state.

○,4 — Key for Partition Selection (to be operated in combination with the above "3")

- ◆ When there is no paging in MIC and the left LED light is Always ON or dies out, the corresponding LED lights will flash after pressing the corresponding keys, which indicates that the user has selected this partition;
- ◆ When MIC is paging currently, the corresponding key is pressed or held down to indicate that the user needs to modify the current paging partitions.

Notes:

1. If the indicator light of corresponding partition of the key is green – close the paging of the partition currently selected;
2. If the indicator light of corresponding partition of the key is OFF – open the partition currently selected, namely, increase the paging partitions;

○,5 — Key "Select All"

- ◆ When there is no paging in MIC:
 1. If all "Select All" lights of the partitions flash, the selection of all partitions will be cancelled by pressing this key;
 2. If the user has only selected some partitions, all partitions will be selected by pressing this key.
- ◆ When MIC is paging, please refer to the description of the above "4";

Select All – it can only select 12 partitions at most as to the partition operation mode. But, as to the grouping mode, 12 groups shall be all selected. For example, the user is operated currently in a grouping mode and wants only to start the partition/grouping key “Z/G01”. It contains Partition 1, Partition 88 and Partition 120. Other partitions cannot be selected. At this moment, the user can only configure Group 1 through the “Group Configuration” in “Paging” of PAVA6000 Configuration, and the partitions selected in other 11 groups will all be subject to an inverse selection. After the synchronous configuration of corresponding partitions, to select Partition 1 in the panel is equivalent to the simultaneous selection of 3 partitions in the partition mode, but the selection of other partitions is invalid.

○,6 — Key “Paging Startup”

◆ MIC Paging Control Key

Notes:

1. When it is paging, the current paging will be ended by pressing this key;
2. When there is no paging but the partition is selected, it will begin the paging by pressing this key (it will wait for the ON of the microphone light);

Attentions:

When the MIC is operated in the PTT mode, this key shall be always held down for a paging operation; otherwise the paging will end (PTT mode refers to the description in the later “11”).

○,7 — MIC Power Switch

- ◆ It is used to start or close MIC operating power supply (it must be firstly connected to the host, namely, “8” must be connected with “7” in the rear row of the host)

○,8 — Device Online Interface

- ◆ It is used to connect the system host or one set of upper/lower PAVA6006.

For these two interfaces, there is no distinction between the major and the minor one.

○,9 — MIC Output Audio Sensitivity Adjustment

○,10 — MIC External Line Input Audio is output by mixing with the Audio of “2” of the Panel

○,11 — Device ID Configuration Switch

Bits “1-5” – means the device online ID. The online IDs of the device in the below are respectively: (namely, the binary value of device ID is the bits 1-5 plus 1. to pull on means “1” and to pull off means “0”).

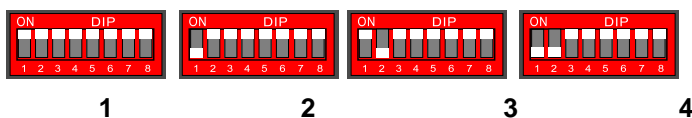

"6" – to pull on means that "6 – Paging Start Key" is operating in a common mode, and to pull off means that "6 – Paging Start Key" is operating in a PTT mode, namely, it shall be always held down for a paging;

"7" – Control whether it is a group or a separate partition corresponding by one key in MIC "4 – Partition Selection Key". To pull on indicates that it corresponds to one separate partition, and to pull off indicates that it corresponds to one group (including all partitions in the system).

"8" – MIC panel "LED" light test (please remain the PULL-ON if it is normal). When the PULL-OFF is detected, all LED lights on the panel will automatically restore to their normal display states after lighting in an order of Red → Green → Yellow. It is used mainly to test whether the display of LED lights is normal or not.

1.5. Technical Specification

✧ Electrical Indicators

Phantom Power Supply

Voltage:	20V ~ 27.5V
Max. Current:	<0.1A (24Vpower supply, lighting of all panel LED lights, in a paging state)
Power Consumption:	<2.4W

Performance Indicators

Line Input	
Sensitivity:	775mV
Impedance:	10kΩ
SNR:	>70dB

Microphone

Sensitivity:	5mV
Impedance:	600Ω

✧ Mechanical Indicators

Size (Length x Width x Height):	240* 140 * 55 mm
Net Weight:	1kg or so
Installation:	Desktop
Color:	Black

✧ Environment Requirements

Operating Temperature:	+5	°C ~ +40°C
Storage Temperature:	-20	°C ~ +70°C
Relative Humidity:	<95% (No condensation)	

4.1. Host Lines 01-06 for Manual Playing

- ✧ The corresponding partitions can be opened or closed by selecting the corresponding keys on the control panel of PAVA6500 or PAVA6500E:

The lighting (ON) of “BGM” LED of corresponding partitions of PAVA6500 or PAVA6500E indicates that this partition is outputting the audio of the line selected currently by the user.

Notes:

1. The input audio of host line cannot be outputted by transmitting it to the partition of extended host, but the EVAC voice of the host and the audio of handheld microphone and PAVA6006 can be outputted by transmitting it to the extended host;
2. The audio of the extended host cannot be outputted by transmitting it to the partition of the host;
3. When it is necessary to output the audio of different lines, the user can only need to make “LINE OF CONTROL (LINE CONTROL)” to point to corresponding index numbers of the lines.

4.2. Manual Playing of EVAC Voice

- ✧ Enter the “EMERGENCY” Mode – in the OFF state of Emergency LED, press it to make the LED to flash in a rhythm;
- ✧ Select the output partitions (the method is identical to the above “Host Line 01-06 for Manual Playing”. In the manual mode, it is impossible to select the partitions of extended host on the host panel. The automatic mode or PAVA6006 or PAVA6500FM is available);
- ✧ Select the outputted EVAC Voice – it will be OK when the corresponding LED lights of “EVAC MSG” or “ALERT MSG” are ON.

Description:

There are tow ways (execute the same functions) to exit from the EMERGENCY Mode (i.e. Reset)

Way 1: Press again the Key “EMERGENCY” to die out the corresponding LED lights;

Way 2: Enter the relay short-circuit signals (without voltage) with a value $\geq 0.5S$ through the CIE reset input contact at rear row of the host.

4.3. Automatic Triggering of EVAC Voice

- ✧ The user has effectively configured the contacts of the host or extended host via PAVA6000.
- ✧ If it is not configured, it is subject to a output of whole partition in system default;
- ✧ As to the Contact Mode and Level Mode, the EVAC voice can be triggered through the closing in the following figures of the host or extended host (the exit can be realized by the same reset mode of manual playing)

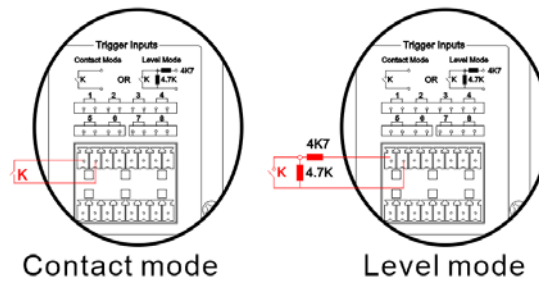

4.4. PAVA6000 Operation

◇ There are two control ways of the system partitions in PAVA6000:

Way 1: select the specified groups or all groups → specify the effective line input of the host, as shown in the following figure:



Notes:

1. PAVA6000 automatically identify the valid input line currently selected by the user as the ENABLE; Otherwise it is marked as the DISABLED State;

2. Because Group 2 in the "Group" of "SYSTEM CONFIGURATION" has only configured the Group 2 of the host, only Partition 2 is displayed in the list box in the right.

Way 2: Single partition operation (this operation is only to singly open or close the partition and it cannot control the type of current output audio):

Click the above of corresponding partition name (a button will appear) → click this button to control this partition, as shown in the following figure:

Step01. Move the mouse to "Zone 01";

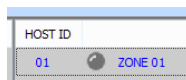

Step02. Click the left mouse button - an anti-color button appears;

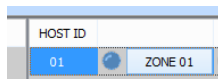

Step03. Click the left mouse button to control the output state of current partition (LED lights green for output and die out for closing);

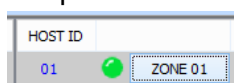

4.5. Paging Operation Using Emergency Microphone

At any time, press the handheld microphone switch for the paging operation (if the user starts up the Prompt (bell voice), the host will automatically play and the paging operation cannot be carried out until the playing is over) → “EMG MICROPHONE” turns ON → begin the paging.

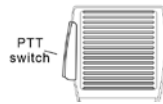

Note: during the paging process, the user can manually close or open the partition/zone. For a default mode, all zones will be opened.

4.6. Operations in PAVA6006 are as follows

- ✧ Select the partition/zone needing currently for paging (the LED light of corresponding selected zone flashes green) – single selection or all selection can be available;
- ✧ Press the Green “CALL” key and wait the lighting of LED light, then the paging is available (if it is operated in the PTT mode, please do not release the button “CALL”);
- ✧ Press again the button “CALL” to end the paging operation (it is only required to release the button for the PTT mode).

Note: the selections on the panel for the grouping and zoning operations are the same, and only the final execution outcomes are different.

● Software Introduction (PAVA6000)

❖ Description of Icons in the Software



Save and meanwhile synchronize the user's currently modified result to PAVA6500 host (it is required to click this button for each modification by the user). In the subsequent descriptions, to click “Application” indicates a clicking of this button.

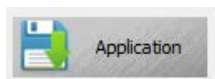

Save but not synchronize the result to the PAVA6500 host. In the subsequent description, to click “OK” indicates the clicking of this button;

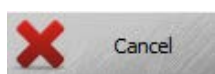

Cancel the reference result currently modified by the user. In the subsequent description, to click “Cancel” indicates the clicking of this button



Prohibit the operation of current partition;



Current partition is operating;



Current partition impedance is changing (open circuit or short circuit);



Current partition is normal and no audio is playing;



Current partition is playing EVAC voice message;



Current system module works normally;



Current system module is in trouble;



Indicating that the current host works normally;



Indicating that the current host is in trouble.

Note: HOST 01 represents the system host, namely, PAVA6500, and the extended

host 1 is: HOST 02 Initialize

2. Initialization

2.1. Computer configuration

Platform: AMD/Inter CPU 2.0G, Window XP SP3/Window 7/8/8.1/10;

2.2. Installation

✧ Please double-click or select “Run as administrator” by right mouse button, and then continue to click “YES” and “Next”.

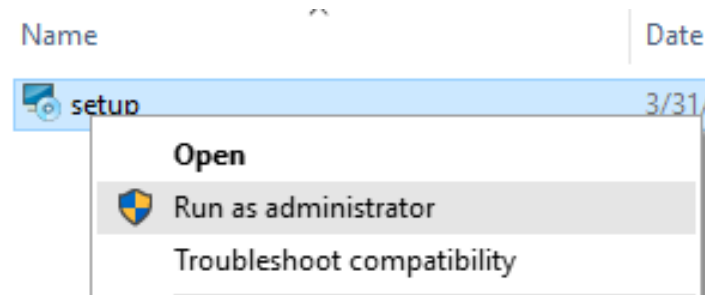

Note: because the operating system of WIN7 or above has comprehensively enhanced its security performance, please ensure to log in the operating system with an identity of administrator; otherwise it may lead to the error during the software installation and during the running after installation. Please check whether the administrator authority is obtained before running – method is as follows:



✧ Find the icon  on the desktop, click the right mouse button to select “Properties” and then check the “Run this program as an administrator” in the following figure.

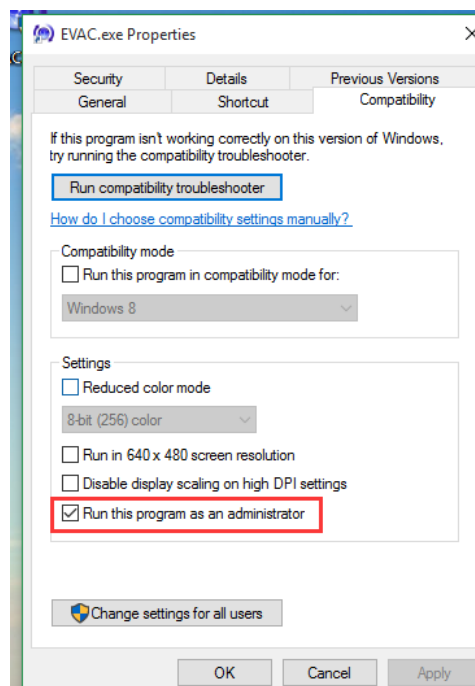

Note: Please maintain the computer and the EVAC system host in the same network segment before the login in the PAVA6000.

- ① use the static IP address connection method (pull off the fifth bit in the rear-row SWITCH ID setting of PAVA6500 host):

❖ find the icon  in the lower right corner of your computer (the icon may be different for different operating systems, so please refer to the actual icon), click the right mouse button to select "Open Network and Sharing Center", and then select " Change adapter settings " in the pop-up window, as shown in the following figure:

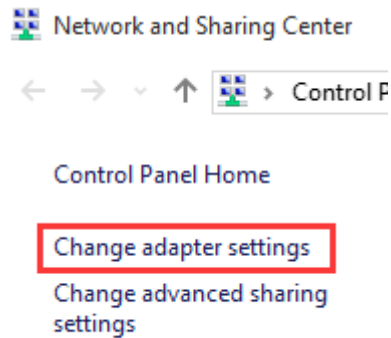

❖ In the pop-up window, select the network connection for current communication (there are maybe many network connections for the interface of user, so please select the network connection communicating currently with the host). Click the right mouse button to select "Properties" and find Item "Internet Protocol Version 4(TCP/IPv4)" in the listbox, and then click the "Properties" in the lower right corner for modification and finally click the "OK".

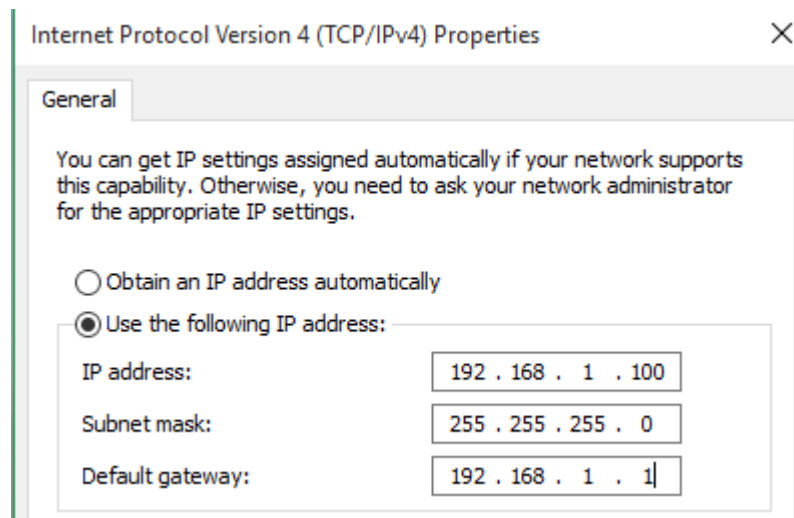

- ② When the user computer uses the dynamic ID address, the operation method is as follows (if the connection is failed, it may be caused by the limitation of router of the user. In such a case, please refer to the above method 1):

❖ Pull On the SWITCH at the rear row of PAVA6500 host;

❖ The host is connected through the cable network to "LAN" port of the router connected by the user computer. In such a case, the host will automatically apply for a legal IP address to the user router.

a. Default Network Parameter of the Host:

IP address: 192.168.1.168
 Sub mask: 255.255.0.0
 Default gateway: 192.168.1.1

- b. User can make the modification by clicking the network properties in the main menu or tool bar (when the user makes the modification, PAVA6000 will automatically restart to establish the connection with the host upon the network parameters modified by the user).

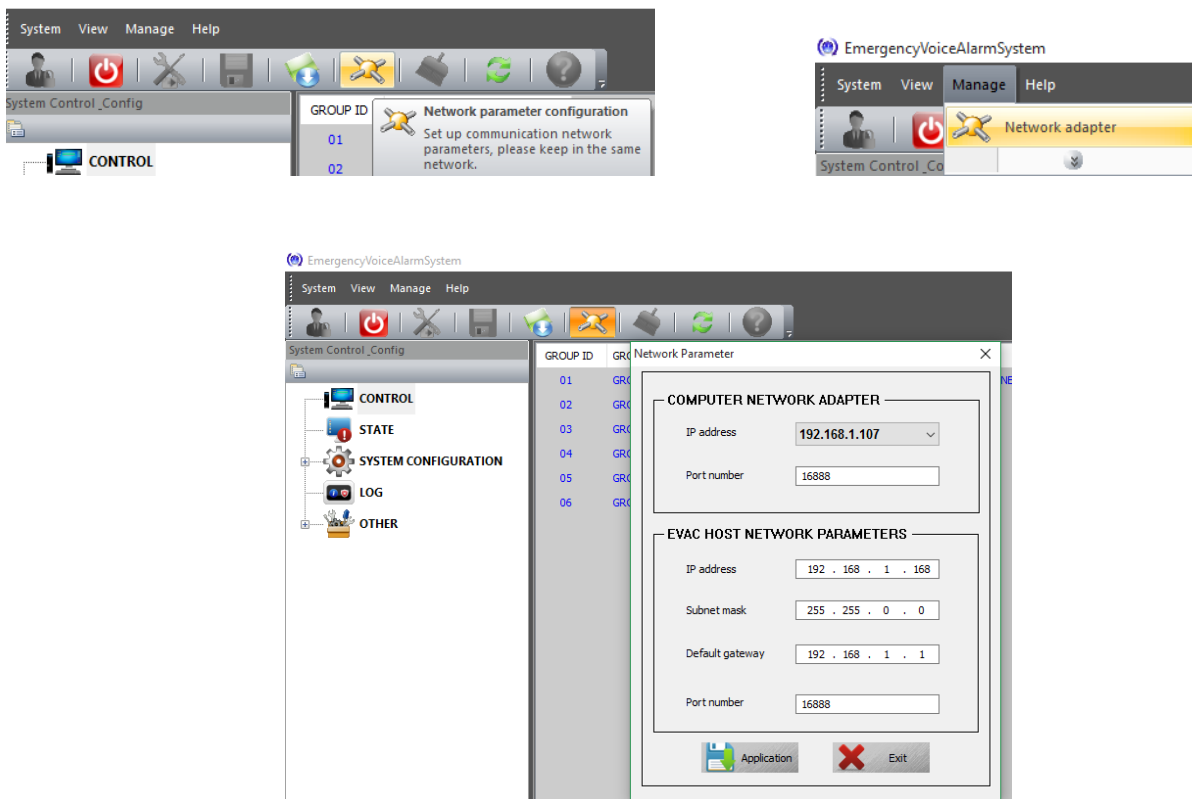

2.3. Uninstall

Please enter the “Programs & Features” in control panel to find the corresponding PAVA6500 and then click and confirm it.

2.4. Operation

2.4.1. Software Login



1. Double-click the icon on the desktop to enter the main menu of the software, as shown in the following figure:

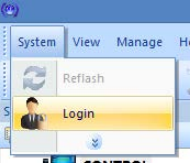

2. Click  or  to enter the user identity interface shown in the following figure: (default value is: Admin or blank), directly click OK or Enter.



Notes:

1. This password can be modified through the “OTHER—user and password” at left side after the login;
2. When the number of times that the user enters the wrong password is more than three times, it will exit from the login interface automatically.
3. The logical connection between PAVA6000 and PAVA65000 is as follows

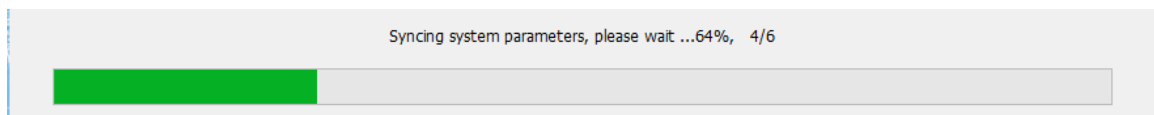

4. Enter the following interface after syncing the system parameters (Fig.1)

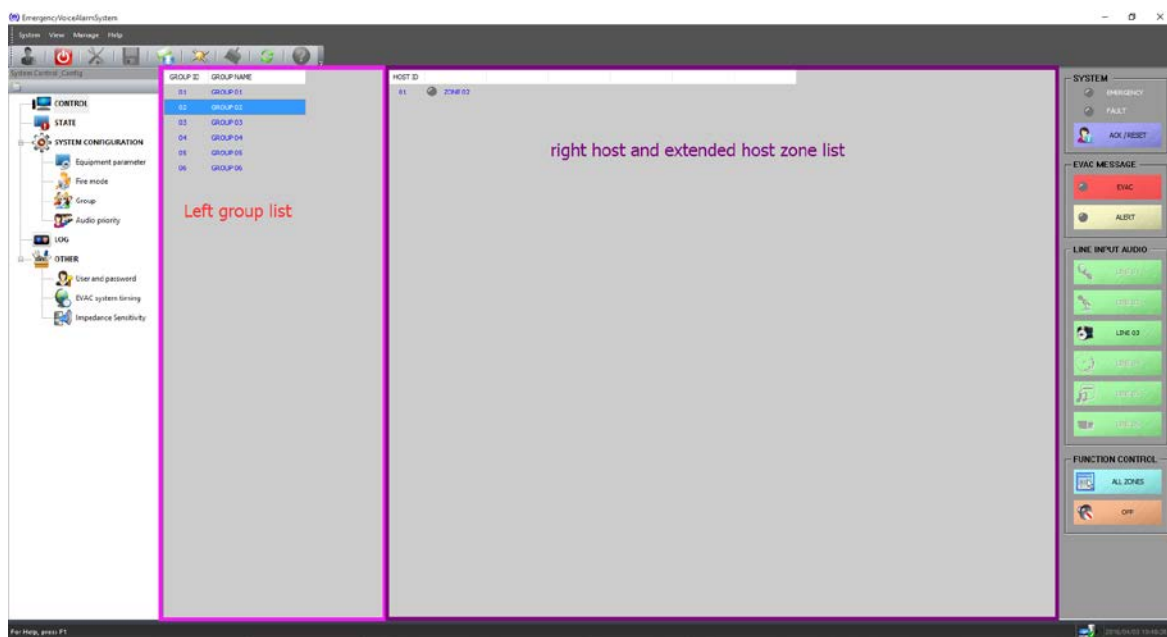

Note:

In the above figure, in its top is the system menu and toolbar, at the left side is the selection items of current operation interface, in the middle portion is the detailed operation items of current selection interface of the user, at the right side is the system status, voice message, line input and function buttons, and at the bottom are prompt bar and software online status and current data of the system, respectively.

2.4.2. Introduction of Control Interface

2.4.2.1. Introduction of Menu Bar and Tools

1. Four main menus of the software in the upper right corner

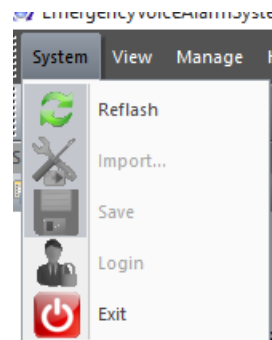

① “System” Menu is shown in the right figure:

- ❖ “Reflash” refreshes the up-to-date status of the interface in which current user is located and it is equivalent to the

icon  in the toolbar;

- ❖ “Import” is used to import the PAVA6500 system configuration saved by the user and it is equivalent to the icon

 in the toolbar;

- ❖ “Save” is used to save the LOG message of system modules or user’s configuration, and it is equivalent to the

icon  in the toolbar;

- ❖ “Login” and “Exit” means the login or exit from the PAVA6000, and it is equivalent to the icon “” in the toolbar.

② “View” Menu is an Interface and it is used to customize the personalized display appearance for the user;

③ “Manage” menu:

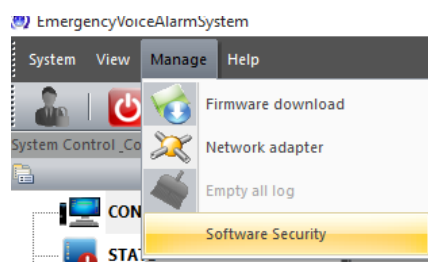

- ❖ “Firmware download” is used to replace the firmware of PAVA6500 host. Please take care in the operation (please refer to the upgrading portion of PAVA6500 host firmware);

- ❖ "Network adapter" is used to modify the reference of host network, which shall be kept consistent with the current network of the user;
- ❖ "Empty all log" is used to delete all status records or logs of host system modules (please take care in operations, and please refer to the following chapters LOG);
- ❖ "Software Security" is used to enhance the operation security, namely, the security authentication as the user exits. If it is "checked", it is necessary to enter the password as the user exits the software.

④ **"HELP" menu is used mainly to view the software version.**

2.4.3. Introduction of "Current Operating Interface Selection"

Overview: "CONTROL" will control the system partition output status together with audio control button at the right side, including PAVA6500 system grouping configurations, the output control of single partition (zone) of specified PAVA6500 host or PAVA6500E Extended host.

1. "STATE" is used to check the operating status of system devices and modules;
2. "SYSTEM CONFIGURATION" is used to check or modify the current working parameter configuration of the system devices or equipment;
3. "LOG" is used to check the logs or records of system devices and modules;
4. "OTHER" is used to modify the user's password, proofread the time of PAVA6500 host and modify speaker circuit impedance error value of PAVA6500 system. The greater the percentage is, the lower the accuracy will be.

2.4.3.1. Partition Control

Login the software or click the "CONTROL" at left side, display as shown in the above (Fig.1). The user information is provided in the above figure interface:

- ① On the central left side, it displays that there are six groups using the PAVA6000 controllable system;
- ② On the central right side, it displays that the current system has six partitions/zones;
- ③ The red LED on the right top indicates that the current system operates in an emergency mode;
- ④ The yellow LED indicates that the current system module is in trouble;
- ⑤ The die-out of LED lights of red and yellow EVAC voice buttons indicates that the EVAC voice message in SD card is OK, namely, the EVAC voice message in "evac_message" and "alert_message" folder in the SD card is intact.

Notes:

① On the left side is the control knob of current output lines of PAVA6500 or PAVA6500E panel. The PAVA6000 panel only displays the current output of valid line of the host;

② PAVA6000 controllable system groups can be set up as Groups 0-120. Through the configuration quantity of "Equipment parameter" in "SYSTEM CONFIGURATION" (6 parameters in default), the system partitions/zones contained by each group can be set up via the "Group".

③ If want to display the current status of all zones of the system, please move the mouse pointer to the blank space in the group listbox, double-click the mouse or click the button  on the right side;

- ④ If want to check the zones contained in the specified group, please click the corresponding

group item in the group listbox, for example, click Group 6;

⑤ Display as:

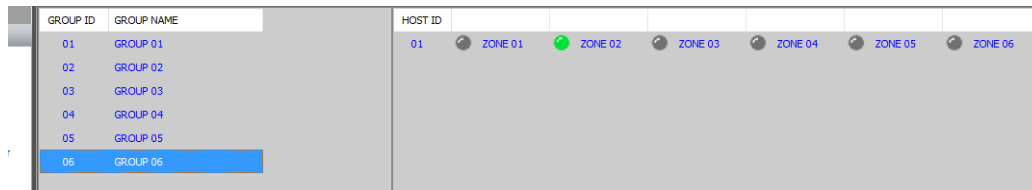

The anti-color display on the central left side in the above figure indicates that it is selected. In the right listbox, 6 zones of the host in current groups are displayed. Of course, you can add or delete more zones of the host or extended host by modifying “Group” in “SYSTEM CONFIGURATION” (Please be sure to click “Application” after completing the modification);

⑥ If the red LED in the upper right corner is ON, you can only reset it through the red button “EMERGENCY” on the PAVA6500 host panel or the rear row “3-Emergency Reset Input”; in the emergency mode, the user can control the start and closing of EVAC Voice via PAVA6000 (the zone can be opened or closed);

⑦ If the yellow LED is ON, the user can have a check in the pop-up window by double-clicking the corresponding device items after clicking the “STATE” column at the left side.

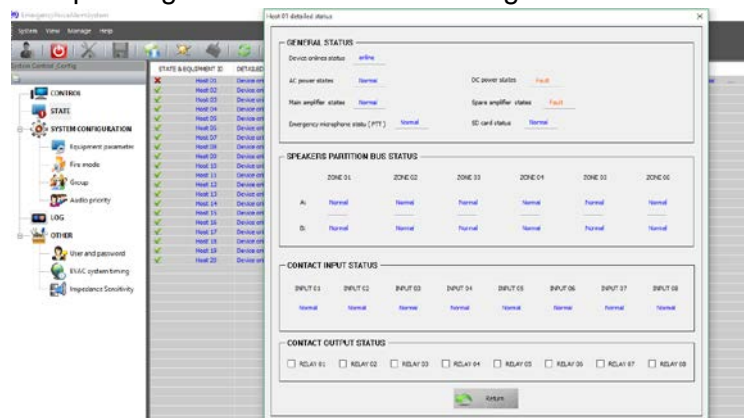

✧ Operation and Control:

① Operations of Specified Host and Specified Zones are as follows (Output the specified audio or close the zones)

➤ Move the mouse pointer onto the “PARTITION 0X” at the right side of “HOST ID” on the central right side, click it and get a button, and then click this button to control this zone. (the button will automatically disappear by clicking any space except this button):

② Control of Single Partition of Specified Host

➤ For example, if you want to control the Partition 2 of the host, you can only find the “Partition 02” on the right side of “01” under the “HOST ID” and click it.

③ Control of Groups (Output the specified audio)

➤ Select the target partitions: use the mouse to select the corresponding groups on the central left side

(the central right listbox will display the partitions contained in the current groups);

➤ Select the output audio: use the mouse to click the ENABLE audio in “EVAC MESSAGE” (needing the emergency status) or “LINE INPUT AUDIO” on the right side.

➤ Control of all system partitions (of course it can achieve the same result by adding all system partitions into one or more groups): Select the target partitions: select output audio after clicking the “ALL PARTITIONS” in the lower right corner (use the mouse to click ENABLE audio in “EVAC MESSAGE” (needing the emergency status) or “LINE INPUT AUDIO” on the right side)

④ Close the Groups:

➤ 1. Select the target partitions:

➤ 2. select output audio: use the mouse to click ENABLE audio in “EVAC MESSAGE” (needing the emergency status) or “LINE INPUT AUDIO” on the right side

2.4.3.2. System Equipment State (STATE)

✧ The column “STATE&EQUIPMENT ID” displays the current system equipment, including the host, extended host and business MIC;



✧ “DETAILED” is the ID state list of corresponding equipment. The user can double-click this item to have a check as to the host and extended host (as shown below):

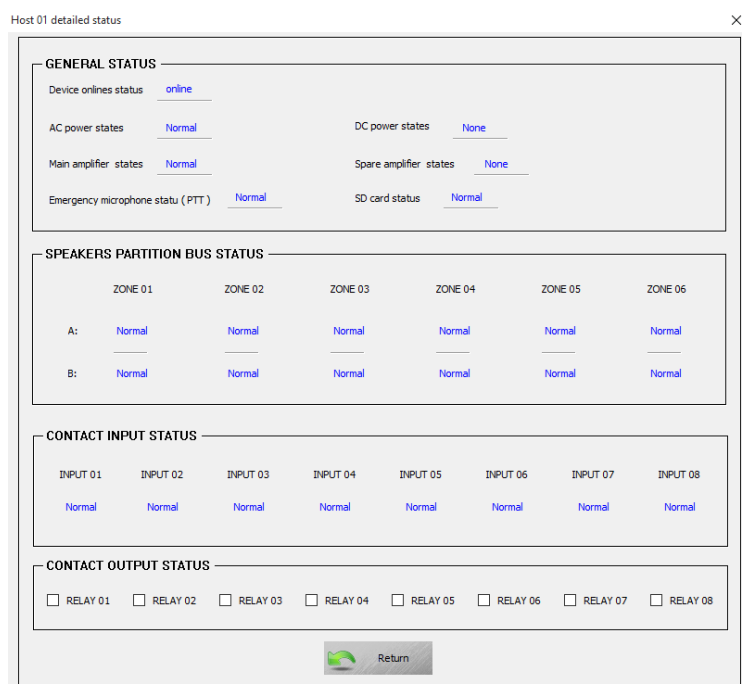

The indicators in the above figure are described as follows:

- ◇“online” indicates that the equipment or device is online;
- ◇“offline” indicates that the equipment or device is offline; in such a case, please test or check whether the online cable is in trouble or there is no such an equipment in the system;
- ◇“Normal” indicates that the corresponding equipment module is normal;
- ◇“Fault” indicates that the corresponding equipment module is in trouble;
- ◇“None” indicates that the rear-row DIP configuration switch of this equipment has disabled this module, namely, it is not configured;
- ◇“Open” indicates that there is an open circuit for the corresponding speaker or CIE test loop, namely, it is detected that the impedance of the speaker circuit exceeds (10-30%), subject to the display in



(do not specify the detection error for the single equipment or the specified partitions) or the cable between the equipment and the CIE device is disconnected (if the current equipment contact input configuration is in “Level Mode”);

- ◇“Short” indicates that there is a short circuit for the corresponding speaker of CIE loop, namely, it is detected that the impedance of the speaker circuit exceeds (10-30%), and the short circuit of the partition is to disable the control of this partition (in order to protect the amplifier, the host will automatically disable the output until the trouble is shot) or the cable between the equipment and CIE loop is in a short circuit (if the current equipment contact input configuration is in “Level Mode”);
- ◇“CONTACT OUTPUT STAUS” refers to that the corresponding equipment online relay output can be controlled by the clicking operation of the mouse; its output status can be programmed in the contact event in the “Fire Mode” on the left side.

2.4.3.3. SYSTEM CONFIGURATION

1. It is used mainly to check or view the detailed configuration parameters of the system equipment;
2. Configure or set the fire alarm rules;
3. Configure the operating system groups in PAVA6000;
4. Modify the priority of equipment audio in the system according to the specific applications;

2.4.3.3.1. Check the Detailed Configuration Parameters of the System Equipment

Find “Equipment parameter” through the “+” on the left side of “SYSTEM CONFIGURATION”, click it to pop up the dialog box of parameter configuration of the host, extended host and business MIC, as shown below:

- ① Configure the host and extended host by setting the number of hosts and extended hosts in the drop-down box on the right side of “Host Number (1-20)” (the system must be equipped with one host. When the number of host of the equipment is over one set, enable the user to use the selector buttons “^” and “v” of many hosts of the user equipment on the right side of “PARTITION ENABLE CONFIGURATION”);
- ② The user can set up the prompt tones of paging start and stop for the handheld microphone of the panel (i.e. EMG MICROPHONE). When the paging is started, it is required to specify in “PUSH” and “RELEASE” the serial number of files saved in “prompt” folder in SD card (namely, serial number of bell voices), of which, Prompt voice switch indicates the startup and Prompt voice switch indicates no start;
- ③ The user may Enable or Disable single partition of the host or extended host according to the actual conditions. When the check box of the partitions of “PARTITION ENABLE CONFIGURATION” is “”, which indicates the ENABLE, and “”, which indicates the DISABLED (it is not allowed for operate, and it seems that there exists no such a partition for the similar equipment. All ENABLE in default).
- ④ Through “Quantity allocation(0-32)”, the user can set the quantity of business microphones or fire microphones that shall be connected into the host and meanwhile click the following “Address assignment...” to further set the operating parameters of the microphones:

ID	NAME	TYPE	ADDRESS
01	Paing 01	Business paing	01

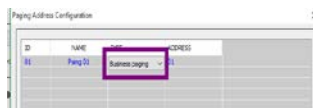

- (1) Item "ID" lists the quantity of microphones that are currently connected to the host – please make the configuration according to the actual equipment;
- (2) Item "Name" is the virtual name of the corresponding microphones, without any actual meaning, which is automatically allocated by the system;
- (3) Item "TYPE" is the type of corresponding microphones, and the user can make a choice for "Fire paging" or "Business paging" by clicking this item;
- (4) Item "ADDRESS" is the address of corresponding microphones. The user shall guarantee that the first 1-5 microphones currently connected to the system in the "Link ID" are subject to the one-to-one correspondence, and otherwise, it may lead to the operation failure of the microphones.

Note: after completing the modification, please double-click the blank space to determine that there is no

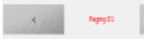

drop-down box in the chart in the listbox, and then click "OK". Otherwise, the modification made just now shall be invalid.

- ⑤ Similarly, the user can set up the switch of each microphone and specify different prompt tone (bell voice) through the "Paging Prompt Tone Switch", and the method is identical to that of the previous microphone of host panel, which will not be described here (the setting of many microphones can be switched by clicking the ).

- ⑥ The user can also set different control partitions for 12 groups of the first microphone according to the actual needs, and meanwhile, add and delete them by clicking the , and switch different groups via the . The display of list box of the groups is described as follows:

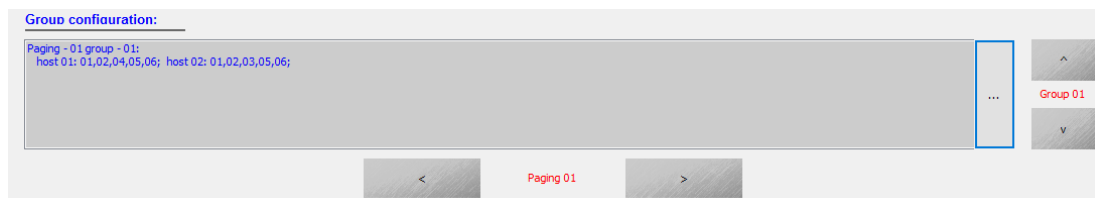

- (1) "Paging -01 group -01: ":
 - 1) "Paging-01" indicates that the group message currently listed is the microphone whose address is 01;
 - 2) "group-01" refers to group 01, of course, it may be group 02 or group 03, with a range of 01-12;
- (2) "host 01: 01, 02, 04, 05, 06; host 02: 01, 02, 03, 05 and 06": it indicates that this partition contains

all partitions of this host (HOST 01 in system default; the user cannot change it) except for Partition 3 and all partitions of extended host 01 except for Partition 4 (extended host is numbered from 02, and the user cannot change it), that's to say, if the user uses the grouping mode in the microphone whose address is 01, the selection of Group 01 for paging is equivalent to the simultaneous selection of five groups of both the host and the extended host for paging.

Precaution: after completing the modification, please click the “Application”. Otherwise, your setting cannot achieve your expected purpose in the corresponding equipment.

2.4.3.3.2. Fire Rules

1. Set the fire execution rules;
2. Set the contact output partition and online relay status;

Click the Item “Fire mode” as shown below:

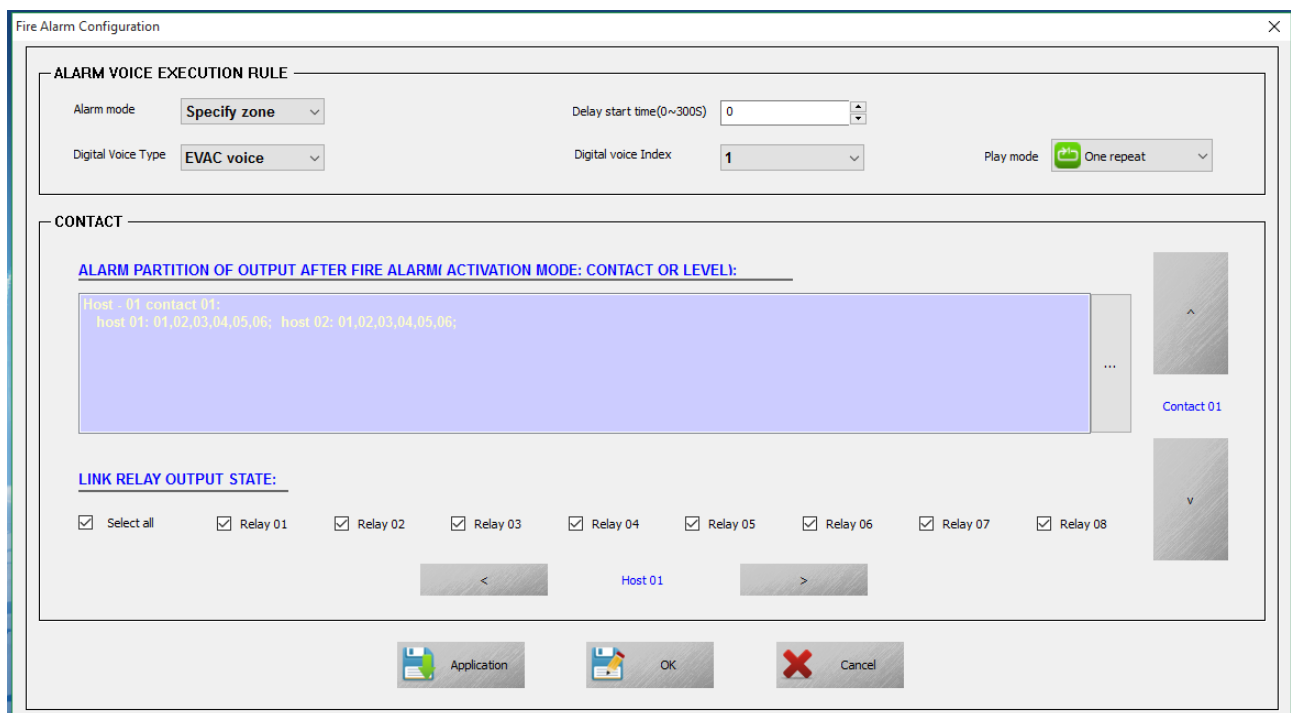

In the above figure:

① the user can select “Specify Partition” or “All partition” from the drop-down box on the right side of “Alarm mode”:

(1) “Specify partition” means that the system will only play EVAC voice message to the specified partition of corresponding contact and close the output to other partitions when the system has detected the input fire signals in “Trigger Inputs” of the host or the extended host (Cautions: when the current output audio is not the EVAC voice and its priority is higher than EVAC voice, the system will only start the fire and will not close the partitions for current output. The user shall pay attention to it while configuring or setting the “Audio priority”);

(2) “All partition” means that once the fire signal is input from “Trigger Inputs” of the host or the extended host, the system will close all partitions and play the EVAC voice;

② The user can set up the delay execution time of fire via the “Delay start time (0-300s)” when the system has detected the input of fire message. Please note: unit of seconds is used. If it is “0”, it indicates no delay and it shall be executed immediately;

③ “Digital Voice Type” is used to select the type of EVAC voice message to be played or broadcasted, which may be the “EVAC Voice” and “Alert Voice”;

④ “Digital voice index” is used to set up the built-in voice message index in the Folder “evac_message” or “alert_message” in the SD card to be played in case of any fire; “Play mode” is used to set up the playing or broadcasting way (it is used for playing the voice message of many segments);

⑤ “CONTACT” is used to set up the output partition and output online relay of each contact of current devices or equipment in case of any fire, namely, one quick operation: multiple operations are integrated into one operation to facilitate the user to respond quickly in case of an emergency, which is similar to the group configuration and operation in the microphone, with the exceptions:

(1) The grouping (groups) shall be manually operated and the contact is mostly used for the linkage via the third-party system in case of uncertainty factors or any emergency;

(2) The grouping operation does not contain the relay output, but the contact contains the relay output, which is easy or convenient to control the third-party system to realize the linkage.

Precaution: after completing the modification, please click the “Application”. Otherwise, your setting cannot achieve your expected purpose in the corresponding equipment.

2.4.3.3.3. Grouping Configuration of the System

Click “Group” in “SYSTEM CONFIGURATION”, as shown below:

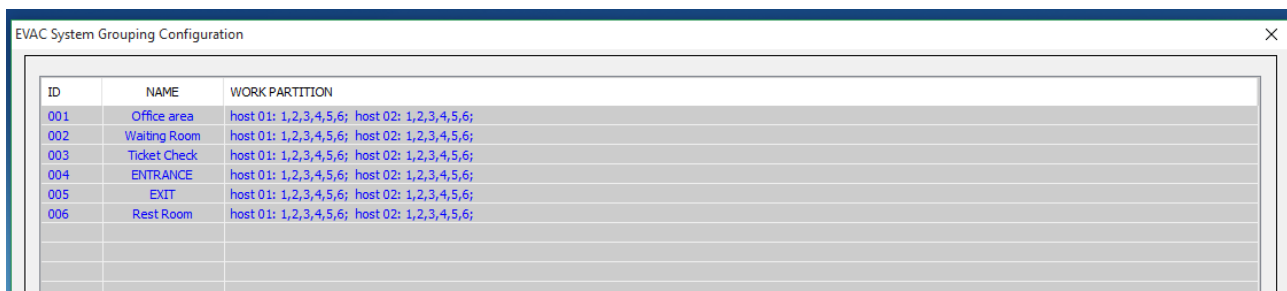

ID	NAME	WORK PARTITION
001	Office area	host 01: 1,2,3,4,5,6; host 02: 1,2,3,4,5,6;
002	Waiting Room	host 01: 1,2,3,4,5,6; host 02: 1,2,3,4,5,6;
003	Ticket Check	host 01: 1,2,3,4,5,6; host 02: 1,2,3,4,5,6;
004	ENTRANCE	host 01: 1,2,3,4,5,6; host 02: 1,2,3,4,5,6;
005	EXIT	host 01: 1,2,3,4,5,6; host 02: 1,2,3,4,5,6;
006	Rest Room	host 01: 1,2,3,4,5,6; host 02: 1,2,3,4,5,6;

Notes:

1. “ID” is a number automatically generated by the system, without any practical significance;
2. “NAME” is used for the user to take a meaningful sign for the groups he has configured, which facilitates the memory of operations, for example, the groups can be configured as shown below (system default value is “GROUP 01...”). The user double-clicks the corresponding item to enter the Edit Status (at most 12 valid characters). Press the “Enter” on the keyboard to quickly enter the next group;
3. “WORK PARTITION” lists the partition list (zone list) contained by the current groups. The user can double-click this item to carry out the addition and deletion of the sub-groups:

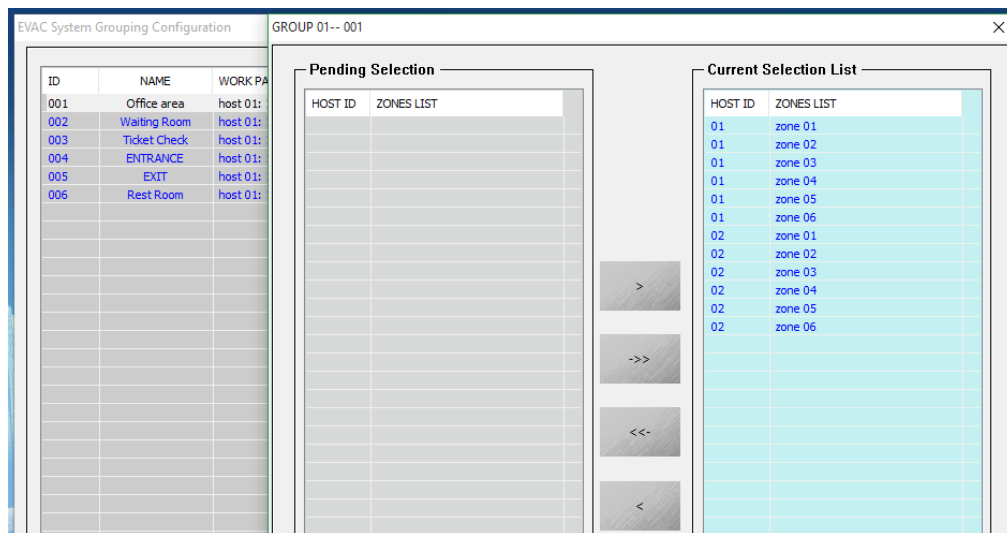

- ① The currently edited partition number is displayed in the upper left corner of the dialog box;
- ② On the left side is the area for selection, namely, the zone list of current system, and on the right side is the partitions contained by current groups. You can realize the continuous and discontinuous selections by double-clicking the corresponding partition or through the combination keys of “Shift” or “Ctrl”, and also add or delete the selections through the intermediate operation button.
- ③ “>” and “<” are the operation of single partition or zone. “>” is to add the system partitions on the left into the current groups and “<” means an reverse operation, namely, delete the selected partition from the current groups;
- ④ “<<” and “>>” are to delete all partition of current groups and add all current system partitions into the current group, respectively.

Precaution: after completing the modification, please click the “Application”. Otherwise, your setting cannot achieve your expected purpose in the corresponding equipment.

2.4.3.3.4. Configuration of Audio Priority of the System

Click “Audio priority” in the “SYSTEM CONFIGURATION”, as shown below:

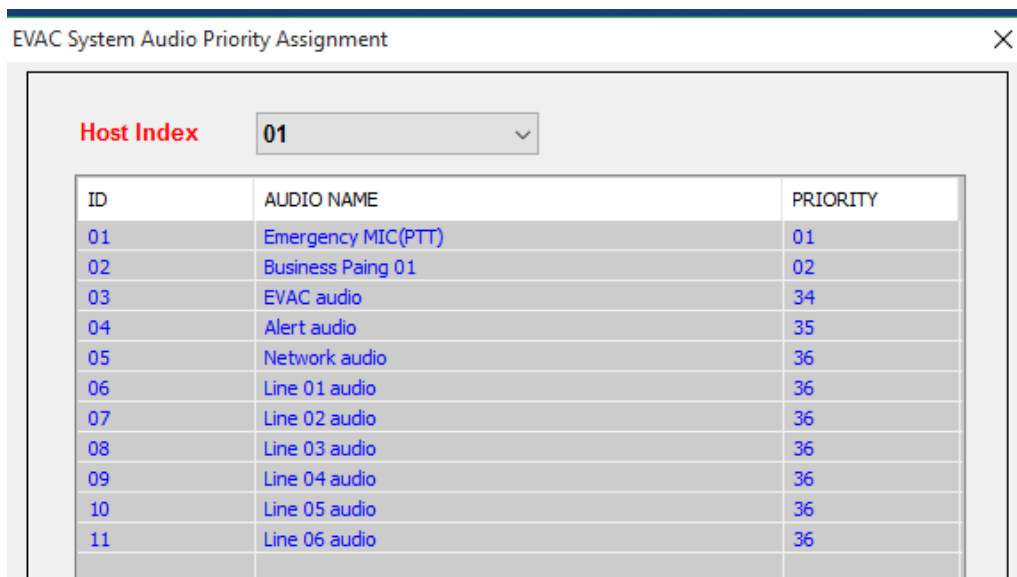



In the above figure:

- ① “ID” is the number automatically added by the system, without any practical significance;
- ② “AUDIO NAME” is the audio in the host equipment;
- ③ “PRIORITY” is the priority of corresponding audio, and it also directly affect whether the current audio has the sufficient output authority. The user shall take care of it while modifying it. The setting in the above figure belongs to the default setting of the system.

Notes:

1. The user can achieve the online or offline configuration of system parameters or save them as “*.cfg”

files for backup by clicking “”;

2. The user can import the backup system configuration parameters through the “” —— it is required to manually synchronize them after the import.

2.4.3.4. Log Query of Equipment Modules

Click “LOG” as shown below:

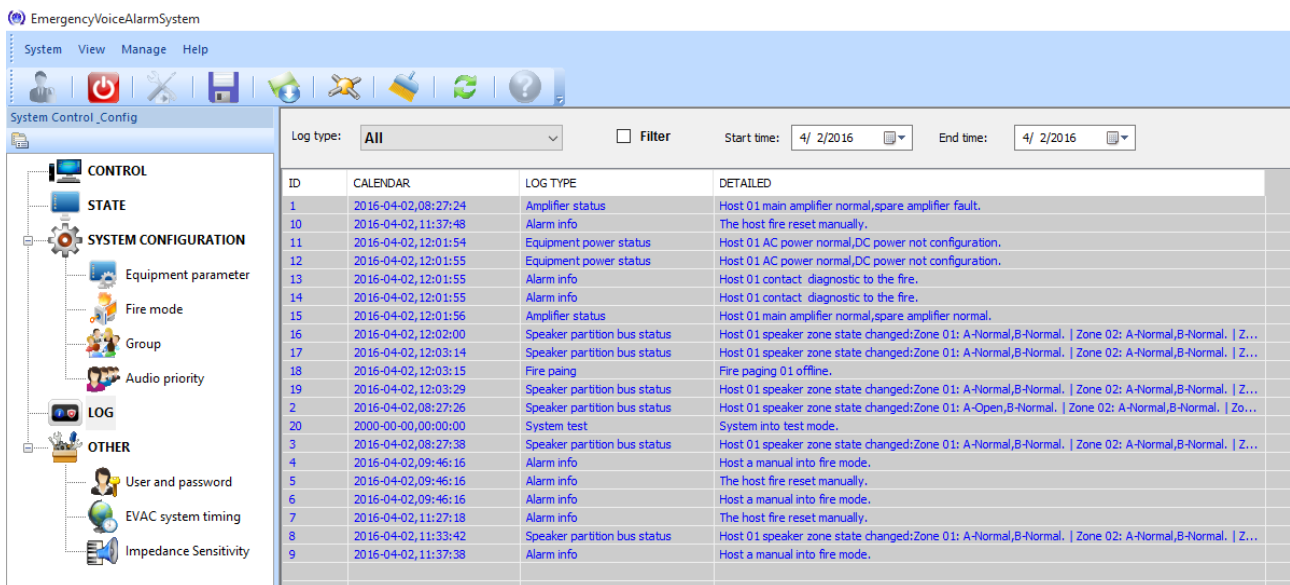

ID	CALENDAR	LOG TYPE	DETAILED
1	2016-04-02,08:27:24	Amplifier status	Host 01 main amplifier normal, spare amplifier fault.
10	2016-04-02,11:37:48	Alarm info	The host fire reset manually.
11	2016-04-02,12:01:54	Equipment power status	Host 01 AC power normal, DC power not configuration.
12	2016-04-02,12:01:55	Equipment power status	Host 01 AC power normal, DC power not configuration.
13	2016-04-02,12:01:55	Alarm info	Host 01 contact diagnostic to the fire.
14	2016-04-02,12:01:55	Alarm info	Host 01 contact diagnostic to the fire.
15	2016-04-02,12:01:56	Amplifier status	Host 01 main amplifier normal, spare amplifier normal.
16	2016-04-02,12:02:00	Speaker partition bus status	Host 01 speaker zone state changed: Zone 01: A-Normal, B-Normal. Zone 02: A-Normal, B-Normal. Z...
17	2016-04-02,12:03:14	Speaker partition bus status	Host 01 speaker zone state changed: Zone 01: A-Normal, B-Normal. Zone 02: A-Normal, B-Normal. Z...
18	2016-04-02,12:03:15	Fire paging	Fire paging 01 offline.
19	2016-04-02,12:03:29	Speaker partition bus status	Host 01 speaker zone state changed: Zone 01: A-Normal, B-Normal. Zone 02: A-Normal, B-Normal. Z...
2	2016-04-02,08:27:26	Speaker partition bus status	Host 01 speaker zone state changed: Zone 01: A-Open, B-Normal. Zone 02: A-Normal, B-Normal. Zo...
20	2000-00-00,00:00:00	System test	System into test mode.
3	2016-04-02,08:27:38	Speaker partition bus status	Host 01 speaker zone state changed: Zone 01: A-Normal, B-Normal. Zone 02: A-Normal, B-Normal. Z...
4	2016-04-02,09:46:16	Alarm info	Host a manual into fire mode.
5	2016-04-02,09:46:16	Alarm info	The host fire reset manually.
6	2016-04-02,09:46:16	Alarm info	Host a manual into fire mode.
7	2016-04-02,11:27:18	Alarm info	The host fire reset manually.
8	2016-04-02,11:33:42	Speaker partition bus status	Host 01 speaker zone state changed: Zone 01: A-Normal, B-Normal. Zone 02: A-Normal, B-Normal. Z...
9	2016-04-02,11:37:38	Alarm info	Host a manual into fire mode.

Notes:

- ① “ID” is a random number, without practical significance;
- ② “CALENDAR” refers to the date of recording this module;
- ③ “LOG TYPE” refers to the type of this log (it is used for filtration in case of a lot of logs. Quick view is available);
- ④ “DETAILED” refers to the detailed contents of current log.

Description:

The user can classify and specify the time frame for view through the “Log Type” and subsequent Filter Start time: 4/ 2/2016 End time: 4/ 2/2016 , and in addition, the user

can save the current log as the spreadsheet by clicking the  in the toolbar.

2.4.3.5. “OTHER” (Other settings)

1. Modify the user password;
2. Calibrate the time of system host;
3. Adjust the impedance error of system speaker partitions;

1. Modify the user password:

- ① Click the “User and password” to pop up the . The user shall enter

the login password (the system will automatically exit from this operation when the user enters the wrong password);

- ② The system will pop up the following window after the user enters the correct password:

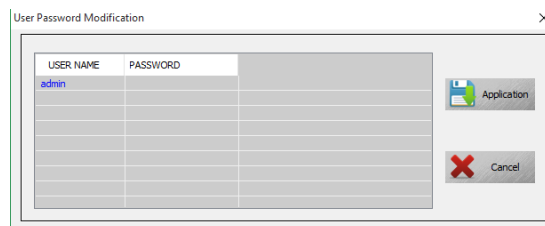

Notes:

① “USER NAME” refers to the user name for current user to log in the system. Double-click to enter the edit mode;

- ② “PASSWORD” refers to the user password for current user to log in the system.

Double-click to enter the edit mode;

Precaution: after completing the modification, please click the “Application”. Otherwise, your setting cannot achieve your expected purpose in the corresponding equipment.

2. Calibrate the Time of System Host

Click “EVAC system timing” to pop up:

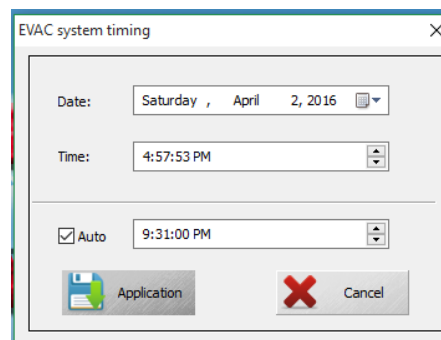

Note:

- ① “Data” & “Time” refer to the date and time. the displayed time is the current computer time;
- ② “Auto” refers to the time used for PAVA6000 to automatically calibrate the host time.

Precaution: after completing the modification, please click the “Application”. Otherwise, your setting cannot achieve your expected purpose in the corresponding equipment.

3. Adjust Impedance Error of System Speaker Partitions

Click “EVAC system timing” and select the error range allowed by current speaker circuit in the pop-up window drop-down list box (it can appropriately increase this percentage in case of any error report of speaker circuit).

● Precautions

- 1) Do not install the equipment in direct sunlight or near a heater because it may enter the protection state and stop the operation due to deformation, fading and high temperature;
- 2) Do not install or store the system equipment in a dusty and humid place, otherwise it may cause the operating stability and intermittent fault of the system equipment;
- 3) The system equipment shall be away as far as possible from the equipment with a strong magnetic field to prevent the high electromagnetic interference from affecting the normal operation of the system equipment;
- 4) Please ensure a appropriate spacing between the equipment or devices for a good ventilation and heat dissipation when many PAVA6500Es are mounted in the same cabinet in the system configuration;
- 5) The remote microphone (PAVA6006) provides the 24V phantom power supply. Please shorten the length of cables when the PAVA6500 indicator light becomes darker or fails to work normally (it is normal for five types of wires/cables after field test of 600m. it is noted that this length of 600m refers to the total length of loop rather than the length of single equipment or device);
- 6) The main system equipment lines are all back up, so please conduct the configurations according to the actual needs. In case of any serious fault, resulting in that the system fails to operate normally, please feel free to contact the after-sales service personnel of this company for repair and treatment. Do not attempt to disassemble the built-in parts for repair and maintenance to prevent the permanent damage of the equipment or modules and avoid the electric shock accidents;
- 7) Please make sure of a good grounding for the equipment in order to ensure the reliable operation of the equipment.