

**DENON** *PROFESSIONAL*

PROFESSIONAL CD PLAYER

**DN-C620**

---

OPERATING INSTRUCTIONS



## IMPORTANT TO SAFETY

### WARNING:

To reduce the risk of fire and electric shock, this apparatus should not be exposed to rain or moisture and objects filled with liquids, such as vases, should not be placed on this apparatus

### CAUTION

#### 1. Handle the power supply cord carefully

Do not damage or deform the power supply cord. If it is damaged or deformed, it may cause electric shock or malfunction when used. When removing from wall outlet, be sure to remove by holding the plug attachment and not by pulling the cord.

#### 2. Do not open the rear cover

In order to prevent electric shock, do not open the top cover. If problems occur, contact your DENON DEALER.

#### 3. Do not place anything inside

Do not place metal objects or spill liquid inside the system. Electric shock or malfunction may result.

Please, record and retain the Model name and serial number of your set shown on the rating label.

Model No. DN-C620

Serial No. \_\_\_\_\_



**CAUTION**  
**RISK OF ELECTRIC SHOCK**  
**DO NOT OPEN**



### CAUTION:

**TO REDUCE THE RISK OF ELECTRIC SHOCK, DO NOT REMOVE COVER (OR BACK). NO USER-SERVICEABLE PARTS INSIDE. REFER SERVICING TO QUALIFIED SERVICE PERSONNEL.**



The lightning flash with arrowhead symbol, within an equilateral triangle, is intended to alert the user to the presence of uninsulated "dangerous voltage" within the product's enclosure that may be of sufficient magnitude to constitute a risk of electric shock to persons.



The exclamation point within an equilateral triangle is intended to alert the user to the presence of important operating and maintenance (servicing) instructions in the literature accompanying the appliance.

### NOTE:

This CD Player uses the semiconductor laser. To allow you to enjoy music at a stable operation, it is recommended to use this in a room of 5°C (41°F) ~ 35°C (95°F).

## LABELS (for U.S.A. model only)

### CERTIFICATION

THIS PRODUCT COMPLIES WITH DHHS RULES 21 CFR SUBCHAPTER J APPLICABLE AT DATE OF MANUFACTURE.

### CAUTION:

**USE OF CONTROLS OR ADJUSTMENTS OR REFORMATION OF PROCEDURES OTHER THAN THOSE SPECIFIED HEREIN MAY RESULT IN HAZARDOUS RADIATION EXPOSURE.**

**THE COMPACT DISC PLAYER SHOULD NOT BE ADJUSTED OR REPAIRED BY ANYONE EXCEPT PROPERLY QUALIFIED SERVICE PERSONNEL.**

## FCC INFORMATION (For US customers)

### 1. PRODUCT

This product complies with Part 15 of the FCC Rules. Operation is subject to the following two conditions: (1) this product may not cause harmful interference, and (2) this product must accept any interference received, including interference that may cause undesired operation.

### 2. IMPORTANT NOTICE: DO NOT MODIFY THIS PRODUCT

This product, when installed as indicated in the instructions contained in this manual, meets FCC requirements. Modification not expressly approved by DENON may void your authority, granted by the FCC, to use the product.

### 3. NOTE

This product has been tested and found to comply with the limits for a Class B digital device, pursuant to Part 15 of the FCC Rules. These limits are designed to provide reasonable protection against harmful interference in a residential installation.

This product generates, uses and can radiate radio frequency energy and, if not installed and used in accordance with the instructions, may cause harmful interference to radio communications. However, there is no guarantee that interference will not occur in a particular installation. If this product does cause harmful interference to radio or television reception, which can be determined by turning the product OFF and ON, the user is encouraged to try to correct the interference by one or more of the following measures:

- Reorient or relocate the receiving antenna.
- Increase the separation between the equipment and receiver.
- Connect the product into an outlet on a circuit different from that to which the receiver is connected.
- Consult the local retailer authorized to distribute this type of product or an experienced radio/TV technician for help.

This Class B apparatus complies with Canadian ICES-003.

Cet appareil numérique de la classe B est conforme à la norme NMB-003 du Canada.

# IMPORTANT SAFETY INSTRUCTIONS

## READ BEFORE OPERATING EQUIPMENT

This product was designed and manufactured to meet strict quality and safety standards. There are, however, some installation and operation precautions which you should be particularly aware of.

1. Read these instructions.
2. Keep these instructions.
3. Heed all warnings.
4. Follow all instructions.
5. Do not use this apparatus near water.
6. Clean only with dry cloth.
7. Do not block any ventilation openings. Install in accordance with the manufacture's instructions.
8. Do not install near any heat sources such as radiators, heat registers, stoves, or other apparatus (including amplifiers) that produce heat.
9. Do not defeat the safety purpose of the polarized or grounding-type plug. A polarized plug has two blades with one wider than the other. A grounding type plug has two blades and a third grounding prong. The wide blade or the third prong are provided for your safety. If the provided plug does not fit into your outlet, consult an electrician for replacement of the obsolete outlet.
10. Protect the power cord from being walked on or pinched particularly at plugs, convenience receptacles, and the point where they exit from the apparatus.
11. Only use attachments/accessories specified by the manufacturer.

12. Use only with the cart, stand, tripod, bracket, or table specified by the manufacturer, or sold with the apparatus. When a cart is used, use caution when moving the cart/apparatus combination to avoid injury from tip-over.
13. Unplug this apparatus during lightning storms or when unused for long periods of time.
14. Refer all servicing to qualified service personnel. Servicing is required when the apparatus has been damaged in any way, such as power-supply cord or plug is damaged, liquid has been spilled or objects have fallen into the apparatus, the apparatus has been exposed to rain or moisture, does not operate normally, or has been dropped.



### Additional Safety Information!

15. ⚡ Marked terminals are HAZARDOUS LIVE and that the external wiring connected to those terminal requires installation by an instructed person or the use of ready-made leads or cords.
16. This product is equipped with a three-wire grounding type plug, a plug having a third (grounding) pin.  
This plug will only fit into a grounding-type power outlet.  
If you are unable to insert the plug into the outlet, contact your electrician to replace your obsolete outlet. Do not defeat the safety purpose of the grounding-type plug.

**CAUTION:****(English)**

To completely disconnect this product from the mains, disconnect the plug from the wall socket outlet.

The mains plug is used to completely interrupt the power supply to the unit and must be within easy access by the user.

Do not expose batteries to excessive heat such as sunshine, fire or the like.

**VORSICHT:****(Deutsch)**

Um dieses Gerät vollständig von der Stromversorgung abzutrennen, trennen Sie bitte den Netzstecker von der Wandsteckdose ab.

Die Hauptstecker werden verwendet, um die Stromversorgung zum Gerät völlig zu unterbrechen; er muss für den Benutzer gut und einfach zu erreichen sein.

Setzen Sie Batterien nicht übermäßiger Wärme aus, z. B. Sonnenstrahlung, Feuer oder dergleichen.

**PRECAUTION:****(Français)**

Pour déconnecter complètement ce produit du courant secteur, débranchez la prise de la prise murale.

La prise secteur est utilisée pour couper complètement l'alimentation de l'appareil et l'utilisateur doit pouvoir y accéder facilement.

N'exposez pas les batteries à une chaleur excessive telle que le soleil, le feu ou autre.

**ATTENZIONE:****(Italiano)**

Per scollegare definitivamente questo prodotto dalla rete di alimentazione elettrica, togliere la spina dalla relativa presa.

La spina di rete viene utilizzata per interrompere completamente l'alimentazione all'unità e deve essere facilmente accessibile all'utente.

Non esporre le batterie a un calore eccessivo, per esempio al sole, al fuoco o altre fonti.

**PRECAUCIÓN:****(Español)**

Para desconectar completamente este producto de la alimentación eléctrica, desconecte el enchufe del enchufe de la pared.

El enchufe de la alimentación se utiliza para interrumpir por completo el suministro de alimentación a la unidad y debe de encontrarse en un lugar al que el usuario tenga fácil acceso.

No exponga las pilas a calor excesivo, como a la luz solar, el fuego, etc.

**VOORZICHTIGHEID:****(Nederlands)**

Om de voeding van dit product volledig te onderbreken moet de stekker uit het stopcontact worden getrokken.

De netstekker wordt gebruikt om de stroomtoevoer naar het toestel volledig te onderbreken en moet voor de gebruiker gemakkelijk bereikbaar zijn.

Stel de batterijen niet bloot aan felle zonneschijn, brand, enzovoorts.

**FÖRSIKTIHETSMÅTT:****(Svenska)**

Koppla loss stickproppen från eluttaget för att helt skilja produkten från nätet.

Stickproppen används för att helt bryta strömförsörjningen till apparaten, och den måste vara lättillgänglig för användaren.

Utsätt inte batterierna för stark hetta såsom solsken, eld eller liknande.

**ATENÇÃO:****(Português)**

Para desligar completamente este produto da corrente, desligue a ficha da tomada eléctrica.

A ficha eléctrica é utilizada para interromper completamente a alimentação da unidade e deve estar num local onde o utilizador lhe possa aceder facilmente.

Não exponha as pilhas a fontes de calor excessivo, como luz solar, fogo ou semelhantes.

# NOTE ON USE / HINWEISE ZUM GEBRAUCH / OBSERVATIONS RELATIVES A L'UTILISATION / NOTE SULL'USO / NOTAS SOBRE EL USO / ALVORENS TE GEBRUIKEN / OBSERVERA / NOTA SOBRE UTILIZAÇÃO

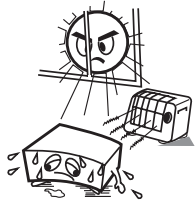

- Avoid high temperatures.  
Allow for sufficient heat dispersion when installed on a rack.
- Vermeiden Sie hohe Temperaturen.  
Beachten Sie, daß eine ausreichend Luftzirkulation gewährleistet wird, wenn das Gerät auf ein Regal gestellt wird.
- Eviter des températures élevées  
Tenir compte d'une dispersion de chaleur suffisante lors de l'installation sur une étagère.
- Evitate di esporre l'unità a temperature alte.  
Assicuratevi che ci sia un'adeguata dispersione del calore quando installate l'unità in un mobile per componenti audio.
- Evite altas temperaturas  
Permite la suficiente dispersión del calor cuando está instalado en la consola.
- Vermijd hoge temperaturen.  
Zorg voor een degelijk hitteafvoer indien het apparaat op een rek wordt geplaatst.
- Undvik höga temperaturer.  
Se till att det finns möjlighet till god värmeavledning vid montering i ett rack.
- Evite temperaturas altas.  
Se instalar o aparelho num suporte, deixe espaço suficiente para a dispersão do calor.

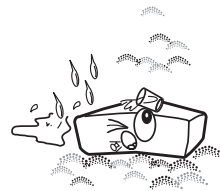

- Keep the set free from moisture, water, and dust.
- Halten Sie das Gerät von Feuchtigkeit, Wasser und Staub fern.
- Protéger l'appareil contre l'humidité, l'eau et lapoussière.
- Tenete l'unità lontana dall'umidità, dall'acqua e dalla polvere.
- Mantenga el equipo libre de humedad, agua y polvo.
- Laat geen vochtigheid, water of stof in het apparaat binnendringen.
- Utsätt inte apparaten för fukt, vatten och damm.
- Mantenha o aparelho livre de humidade, água e pó.



- Do not let foreign objects in the set.
- Keine fremden Gegenstände in das Gerät kommen lassen.
- Ne pas laisser des objets étrangers dans l'appareil.
- E' importante che nessun oggetto è inserito all'interno dell'unità.
- No deje objetos extraños dentro del equipo.
- Laat geen vreemde voorwerpen in dit apparaat vallen.
- Se till att främmande föremål inte tränger in i apparaten.
- Não deixe que entrem objectos estranhos para o aparelho.

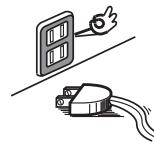

- Unplug the power cord when not using the set for long periods of time.
- Wenn das Gerät eine längere Zeit nicht verwendet werden soll, trennen Sie das Netzkabel vom Netzstecker.
- Débrancher le cordon d'alimentation lorsque l'appareil n'est pas utilisé pendant de longues périodes.
- Disinnestare il filo di alimentazione quando avete l'intenzione di non usare il filo di alimentazione per un lungo periodo di tempo.
- Desconecte el cordón de energía cuando no utilice el equipo por mucho tiempo.
- Neem altijd het netsnoer uit het stopcontact wanneer het apparaat gedurende een lange periode niet wordt gebruikt.
- Koppla ur nätkabeln om apparaten inte kommer att användas i lång tid.
- Desligue o cabo de alimentação da tomada quando não utilizar o aparelho durante longos períodos de tempo.



- Do not let insecticides, benzene, and thinner come in contact with the set.
- Lassen Sie das Gerät nicht mit Insektiziden, Benzin oder Verdünnungsmitteln in Berührung kommen.
- Ne pas mettre en contact des insecticides, du benzène et un diluant avec l'appareil.
- Assicuratevi che l'unità non venga in contatto con insetticidi, benzolo o solventi.
- No permita el contacto de insecticidas, gasolina y diluyentes con el equipo.
- Laat geen insektenverdelgende middelen, benzine of verfverdunder met dit apparaat in contact komen.
- Se till att inte insektsmedel på spraybruk, bensen och thinner kommer i kontakt med apparatens hölje.
- Não deixe que insecticidas, benzeno e diluente entrem em contacto com o aparelho.



- Handle the power cord carefully.  
Hold the plug when unplugging the cord.
- Gehen Sie vorsichtig mit dem Netzkabel um.  
Halten Sie das Kabel am Stecker, wenn Sie den Stecker herausziehen.
- Manipuler le cordon d'alimentation avec précaution.  
Tenir la prise lors du débranchement du cordon.
- Manneggiare il filo di alimentazione con cura.  
Agitare per la spina quando scollegate il cavo dalla presa.
- Maneje el cordón de energía con cuidado.  
Sostenga el enchufe cuando desconecte el cordón de energía.
- Hanteer het netsnoer voorzichtig.  
Houd het snoer bij de stekker vast wanneer deze moet worden aan- of losgekoppeld.
- Hantera nätkabeln varsamt.  
Håll i kabeln när den kopplas från el-uttaget.
- Manuseie o cabo de alimentação com cuidado.  
Segure a ficha quando desligar o cabo de alimentação.

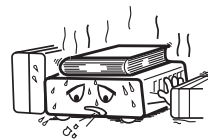

\* (For sets with ventilation holes)

- Do not obstruct the ventilation holes.
- Die Belüftungsöffnungen dürfen nicht verdeckt werden.
- Ne pas obstruer les trous d'aération.
- Non coprite i fori di ventilazione.
- No obstruya los orificios de ventilación.
- De ventilatieopeningen mogen niet worden beblokkeerd.
- Täpp inte till ventilationsöppningarna.
- Não obstrua as aberturas de ventilação.



- Never disassemble or modify the set in any way.
- Versuchen Sie niemals das Gerät auseinander zu nehmen oder auf jegliche Art zu verändern.
- Ne jamais démonter ou modifier l'appareil d'une manière ou d'une autre.
- Non smontate mai, nè modificate l'unità in nessun modo.
- Nunca desarme o modifique el equipo de ninguna manera.
- Nooit dit apparaat demonteren of op andere wijze modificieren.
- Ta inte isär apparaten och försök inte bygga om den.
- Nunca desmonte nem modifique o aparelho.

## CAUTION

- The ventilation should not be impeded by covering the ventilation openings with items, such as newspapers, tablecloths, curtains, etc.
- No naked flame sources, such as lighted candles, should be placed on the apparatus.
- Attention should be drawn to the environmental aspects of battery disposal.
- The apparatus shall not be exposed to dripping or splashing for use.
- No objects filled with liquids, such as vases, shall be placed on the apparatus.

### •DECLARATION OF CONFORMITY

(English)

We declare under our sole responsibility that this product, to which this declaration relates, is in conformity with the following standards:

EN60065, EN55013, EN55020, EN61000-3-2 and EN61000-3-3.

Following the provisions of 2006/95/EC and 2004/108/EC Directive.

### •ÜBEREINSTIMMUNGSERKLÄRUNG

(Deutsch)

Wir erklären unter unserer Verantwortung, daß dieses Produkt, auf das sich diese Erklärung bezieht, den folgenden Standards entspricht:

EN60065, EN55013, EN55020, EN61000-3-2 und EN61000-3-3.

Entspricht den Bestimmungen der Richtlinien 2006/95/EG und 2004/108/EG.

### •DECLARATION DE CONFORMITE

(Français)

Nous déclarons sous notre seule responsabilité que l'appareil, auquel se réfère cette déclaration, est conforme aux standards suivants:

EN60065, EN55013, EN55020, EN61000-3-2 et EN61000-3-3.

Conforme aux dispositions des directives 2006/95/EC et 2004/108/EC.

### •DICHIARAZIONE DI CONFORMITÀ

(Italiano)

Dichiariamo con piena responsabilità che questo prodotto, al quale la nostra dichiarazione si riferisce, è conforme alle seguenti normative:

EN60065, EN55013, EN55020, EN61000-3-2 e EN61000-3-3.

Conforme alle norme delle direttive 2006/95/EC e 2004/108/EC.

QUESTO PRODOTTO E' CONFORME

AL D.M. 28/08/95 N. 548

### •DECLARACIÓN DE CONFORMIDAD

(Español)

Declaramos bajo nuestra exclusiva responsabilidad que este producto al que hace referencia esta declaración, está conforme con los siguientes estándares:

EN60065, EN55013, EN55020, EN61000-3-2 y EN61000-3-3.

Siguiendo las disposiciones de las Directivas 2006/95/CE y 2004/108/CE.

### •EENVORMIGHEIDSVERKLARING

(Nederlands)

Wij verklaren uitsluitend op onze verantwoordelijkheid dat dit produkt, waarop deze verklaring betrekking heeft, in overeenstemming is met de volgende normen:

EN60065, EN55013, EN55020, EN61000-3-2 en EN61000-3-3.

Voldoet aan de bepalingen van de EC-richtlijnen 2006/95/EC en 2004/108/EC.

### •ÖVERENSSTÄMMELSEINTYG

(Svenska)

Härmed intygas helt på eget ansvar att denna produkt, vilken detta intyg avser, uppfyller följande standarder:

EN60065, EN55013, EN55020, EN61000-3-2 och EN61000-3-3.

Följer bestämmelserna i Direktiv 2006/95/EC och 2004/108/EC.

### •DECLARAÇÃO DE CONFORMIDADE

(Português)

Declaramos sob nossa exclusiva responsabilidade que este produto, ao qual se refere esta declaração, se encontra em conformidade com as seguintes normas:

EN60065, EN55013, EN55020, EN61000-3-2 e EN61000-3-3.

De acordo com as disposições da Directiva 2006/95/CE e 2004/108/CE.

**CLASS 1 LASER PRODUCT**  
**LUOKAN 1 LASERLAITE**  
**KLASS 1 LASERAPPARAT**

“CLASS 1  
LASER PRODUCT”

**ADVARSEL: USYNLIG LASERSTRÅLING VED ÅBNING, NÅR SIKKERHEDSAFBRYDERE ER UDE AF FUNKTION. UNDGÅ UDSÆTTELSE FOR STRÅLING.**

**VAROITUS! LAITTEEN KÄYTTÄMINEN MUULLA KUIN TÄSSÄ KÄYTTÖOHJEESSA MAINITULLA TAVALLA SAATTA AALTISTAA KÄYTTÄJÄN TURVALLISUUSLUOKAN 1 YLITTÄVÄLLE NÄKYMÄMTTÖMÄLLE LASERSÄTEILYLLE.**





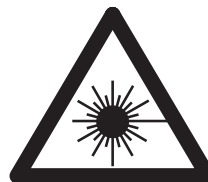



**VARNING- OM APPARATEN ANVÄNDS PÅ ANNAT SÄTT ÄN I DENNA BRUKSANVISNING SPECIFICERATS, KAN ANVÄNDAREN UTSÄTTAS FÖR OSYNLIG LASERSTRÅLNING SOM ÖVERSKRIDER GRÄNSEN FÖR LASERKLASS 1.**

ATTENZIONE: QUESTO APPARECCHIO E' DOTATO DI DISPOSITIVO OTTICO CON RAGGIO LASER.  
L'USO IMPROPRIO DELL'APPARECCHIO PUO' CAUSARE PERICOLOSE ESPOSIZIONI A RADIAZIONI!



**CAUTION:**  
**USE OF CONTROLS OR ADJUSTMENTS OR PERFORMANCE OF PROCEDURES OTHER THAN THOSE SPECIFIED HEREIN MAY RESULT IN HAZARDOUS RADIATION EXPOSURE.**  
**THIS PRODUCT SHOULD NOT BE ADJUSTED OR REPAIRED BY ANYONE EXCEPT PROPERLY QUALIFIED SERVICE PERSONNEL.**



- Use compact discs that include the  mark.  
CD's with special shapes (heart-shaped CD's, octagonal CD's etc.) cannot be played on this set.  
Attempting to do so may damage the set. Do not use such CD's.
- Benutzen Sie Compact Discs, die das  Zeichen tragen.  
Speziell geformte CD's (herzförmige CD's, achteckige CD's, usw.) können auf dieser Anlage nicht abgespielt werden.  
Der Versuch derartige CD's abzuspielen kann die Anlage beschädigen. Verzichten Sie auf die Benutzung solcher CD's.
- Utiliser des disques compacts portant le logo .  
Des CD avec des formes spéciales (CD en forme de coeur, des CD octogonaux, etc.) ne peuvent pas être lus sur cet appareil.  
Le fait de l'essayer, risque d'endommager le lecteur. Ne pas utiliser de tels CD.
- Usare compact disc che includono il marchio .  
I CD con forme particolari (CD a forma di cuore, CD ottagonali ecc.) non possono essere riprodotti su questo apparecchio.  
L'apparecchio si potrebbe danneggiare se si cerca di farlo. Non utilizzare questi CD.
- Use discos compactos con la marca .  
En este equipo no es posible reproducir CDs con formas especiales (CDs con forma de corazón, CDs octogonales, etc.).  
Si intenta hacerlo, el equipo podrá resultar dañado. No use este tipo de CDs.
- Gebruik compact discs voorzien van het logo .  
CD's met speciale vormen (bijv. CD's in de vorm van een hart, achthoekige CD's, enz.) kunnen met dit toestel niet worden afgespeeld.  
Wanneer u dit toch probeert, zal u het toestel beschadigen. Speel dergelijke CD's dus niet af.
- Använd CD-skivor med -märket.  
Specialformade CD-skivor (hjärtformade, åttkantiga, m m) går inte att spela på den här apparaten.  
Utrustningen kan skadas om du försöker göra detta. Använd inte CD-skivor av denna typ.
- Utilize discos compactos que tenham o símbolo .  
Não é possível reproduzir neste aparelho CDs com formatos especiais (CDs em formato de coração, CDs octogonais, etc.).  
Qualquer tentativa de os reproduzir poderá danificar o aparelho. Não utilize esses CDs.

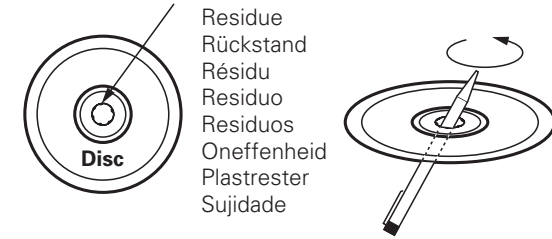

- The disc may not play normally if there is residue along the edges of the center hole.
- When using new discs in particular, use a pen, etc., to remove the residue.
- Die Disk kann nicht normal abgespielt werden, wenn sich ein Rückstand entlang der Mittellochenden befindet.
- Insbesondere, wenn Sie neue Disks benutzen, dann entfernen Sie mit einem Stift, etc. den Rückstand.
- Le disque peut ne pas être lu normalements s'il y a un résidu le long des bord du trou central.
- Lors de l'utilisation de nouveaux disques en particulier, utiliser un stylo à bille, etc., pour enlever le résidu.
- Il disco può non essere riprodotto in modo normale se ci sono dei residui lungo i bordi del foro centrale.
- Usate una penna, ecc., per rimuovere i residui, specialmente quando usate dischi nuovi.
- El disco no puede ser reproducido normalmente debido a la terminación deficiente de los bordes del agujero central.
- Para quitar estos residuos de material, especialmente cuando vaya a re-reproducir discos nuevos, utilice un bolígrafo, o algo similar.
- Het is mogelijk dat de disc niet normaal wordt weergegeven als de randen van het middengat van de schijf oneffenheden vertonen.
- Verwijder vooral bij gebruik van nieuwe discs de oneffenheden met een pen of iets dergelijks.
- Det kan uppstå fel vid CD-avspelingen om det finns plastrester kvar i mitthålet.
- Tänk på att bort dessa med en penna, e d, särskilt om CD-skivan är ny.
- O disco poderá não ser reproduzido normalmente se existir sujidade ao longo das extremidades do orifício central.
- Principalmente quando estiver a utilizar discos novos, utilize uma caneta, etc., para remover a sujidade.





- This unit can display text information on the display when playing CD text discs which contain text information in English category.  
The CD text disc includes the mark shown above.

**NOTE:**

- This unit can provide a text display of the following types of characters. Other types of characters will result in " " being displayed.

- Alphabet  
 ABCDEFGHIJKLMNOPQRSTUVWXYZ  
 abcdefghijklmnopqrstuvwxyz

- Numbers  
 0123456789

- Symbols  
 \_!"#\$%&'()\*+,-./:; <=>?@[#] \_`{|}~ SPACE

- Bei der Wiedergabe von CD-Textdiscs, die Funktionstasten in englischer Kategorie enthalten, kann dieses Gerät auf dem Display Funktionstasten anzeigen.  
Die CD-Textdiscs sind mit dem rechts dargestellten Logo versehen.

**HINWEIS:**

- Dieses Gerät kann aus den nachfolgend aufgeführten Zeichenarten bestehende Texte anzeigen. Bei anderen Zeichenarten wird " " angezeigt.

- Alphabet  
 ABCDEFGHIJKLMNOPQRSTUVWXYZ  
 abcdefghijklmnopqrstuvwxyz

- Zahlen  
 0123456789

- Symbole  
 \_!"#\$%&'()\*+,-./:; <=>?@[#] \_`{|}~ SPACE

- Cet appareil peut afficher les textes d'information lors de la lecture de CD qui comportent ces textes, dans la catégorie anglaise.  
Les CD avec texte se repèrent à la marque indiquée à droite.

**REMARQUE:**

- Cet appareil permet l'affichage de textes composés avec les types de caractère suivants.  
Tous les autres types de caractère seront affichés ainsi " " .

- Alphabétiques  
 ABCDEFGHIJKLMNOPQRSTUVWXYZ  
 abcdefghijklmnopqrstuvwxyz

- Chiffres  
 0123456789

- Symboles  
 \_!"#\$%&'()\*+,-./:; <=>?@[#] \_`{|}~ SPACE

- Quest'unità può visualizzare dei testi sul display durante la riproduzione di CD che contengono dei testi in inglese.  
Il disco CD con testi include il marchio mostrato qui a destra.

**NOTA:**

- Quest'unità è in grado di fornire una visualizzazione dei testi usando i seguenti tipi di caratteri. Altri tipi di caratteri causeranno la visualizzazione dell'indicazione " " .

- Alfabeto  
 ABCDEFGHIJKLMNOPQRSTUVWXYZ  
 abcdefghijklmnopqrstuvwxyz

- Numeri  
 0123456789

- Simboli  
 \_!"#\$%&'()\*+,-./:; <=>?@[#] \_`{|}~ SPACE

- Esta unidad puede mostrar información de texto en la pantalla cuando se reproducen discos CD de Texto que contengan información de texto en la categoría de Inglés.  
Los discos CD de Texto incluyen la marca indicada a la derecha.

**NOTA:**

- Esta unidad puede mostrar visualizaciones de texto de los siguientes tipos de caracteres.  
Otros tipos de caracteres harán que se visualice " " .

- Alfabeto  
 ABCDEFGHIJKLMNOPQRSTUVWXYZ  
 abcdefghijklmnopqrstuvwxyz

- Números  
 0123456789

- Símbolos  
 \_!"#\$%&'()\*+,-./:; <=>?@[#] \_`{|}~ SPACE

- Dit toestel kan tekstinformatie op het display tonen bij het weergeven van CD-Text discs met tekstinformatie in de categorie Engels.  
Een CD-Text disc is voorzien van het logo rechts.

**OPMERKING:**

- Dit toestel kan de volgende tekens als tekst weergeven. Voor andere types van tekens verschijnt " " op het display.

- Alfabet  
 ABCDEFGHIJKLMNOPQRSTUVWXYZ  
 abcdefghijklmnopqrstuvwxyz

- Getallen  
 0123456789

- Symbolen  
 \_!"#\$%&'()\*+,-./:; <=>?@[#] \_`{|}~ SPACE

- Denna apparat kan visa text på displayen när du spelar CD-textskivor innehållande information på engelska.  
CD text-skivor bär märket som anges på höger sida.

**OBSERVERA:**

- Apparaten kan visa text med följande teckentyper. För övriga tecken kommer " " att visas.

- Alfabetiska

ABCDEFGHIJKLMNOPQRSTUVWXYZ

abcdefghijklmnopqrstuvwxyz

- Siffror

0123456789

- Symboler

!"#\$%&'()\*+,-./:;=<>?@[#\]^\_`{|}~ SPACE

- Este leitor pode mostrar informações de texto no visor durante a reprodução de discos CD Text que contenham informações de texto na categoria de Inglês.  
O disco CD Text apresenta o símbolo mostrado acima.

**NOTA:**

- Este leitor permite a visualização de texto com os tipos de caracteres que se seguem. Qualquer outro tipo de caracteres resultará na visualização de " ".

- Alfabeto

ABCDEFGHIJKLMNOPQRSTUVWXYZ

abcdefghijklmnopqrstuvwxyz

- Números

0123456789

- Símbolos

!"#\$%&'()\*+,-./:;=<>?@[#\]^\_`{|}~ SPACE

## – TABLE OF CONTENTS –

1. GENERAL INFORMATION .....	2
FEATURES .....	2
PART NAMES AND FUNCTIONS .....	2
2. PREPARATIONS .....	9
INSTALLATION .....	9
CONNECTIONS .....	10
3. DEVICE OPERATION .....	11
SUPPORTED AUDIO CD .....	11
INSERTING AND EJECTING A DISC .....	11
NORMAL CD PLAYBACK .....	12
ADVANCED CD PLAYBACK .....	15
PLAYING AUDIO FILES .....	21
PRESET FUNCTIONS AND OPERATIONS .....	25
4. CONTROL FEATURES .....	32
RS-232C CONTROL .....	32
GPIO (Parallel) CONTROL .....	39
RC In Control IR FLASH Jack .....	40
5. TROUBLESHOOTING .....	41
6. SPECIFICATIONS .....	42

## ■ ACCESSORIES

Check that the following parts are included in addition to the main unit:

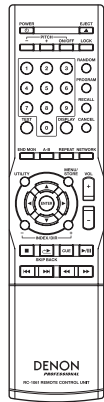
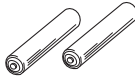
① Remote Control Unit (RC-1061) .....	1
	
② Size "AAA" batteries .....	2
	
③ Audio Cord (Stereo) .....	1
④ AC Power Cord .....	1
(Europe models) .....	2
⑤ Operating Instructions .....	1
⑥ CD-ROM .....	1
⑦ Warranty card .....	1

### A NOTE ABOUT RECYCLING:

This product's packaging materials are recyclable and can be reused. Please dispose of any materials in accordance with the local recycling regulations.

When discarding the unit, comply with local rules or regulations.

Batteries should never be thrown away or incinerated but disposed of in accordance with the local regulations concerning chemical waste.

This product and the accessories packed together constitute the applicable product according to the WEEE directive except batteries.



# 1. GENERAL INFORMATION

## FEATURES

### ■ Standard Functions of Professional CD Player

- Slot-In Disc Drive
- Reads and Displays CD TEXT & MP3 ID3 Tags
- Quick Track Search with Jog Wheel
- Cue to Music
- Balanced Audio Output with Trim
- 2 Sets of Unbalanced Audio Outputs (1 Fixed / 1 Variable level)
- SPDIF Digital Audio Output
- Plays Back Audio Files from a CD Data Disc
- Reads CD-R / CD-RW discs
- Supports CD-DA, WAVE, MPEG-1 Layer III (MP3)

### ■ Advanced CD Playback

- Quick Replay (Skip Back) (Time programmable)
- +/- 12% Variable Pitch Control
- Program Play
- Single, All, A-B Repeat modes
- Random Play mode
- User – Selectable Play Mode (Stop, Next, Recue, Continuous, Random)
- Auto Cue
- End Monitor
- End of Message (EOM) indicator

### ■ 19-inch 1U rack space

### ■ IR Remote Control (Remote controller RC-1061 included)

### ■ External Remote Control

- Serial control (RS232C)
- Parallel control
- RC In Control (IR FLASH)

## PART NAMES AND FUNCTIONS

### (1) Front panel

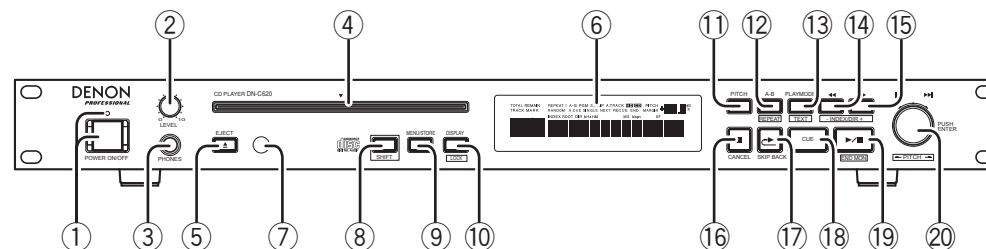

#### ① POWER ON/OFF switch and indicator

- Press this to turn the Power ON or OFF.
- The indicator lights when the power is turned on.

#### ② LEVEL control

- Use this to adjust the output level of the headphones.

#### Warning!

- When using headphones, take care not to turn the volume too high. Listening at high volumes for extended periods of time may result in permanent hearing damage.

#### ③ PHONES Jack

- For private listening, you can connect your headphones to this jack.

#### ④ DISC slot

- Insert a CD into the slot, label side upwards.

#### ⑤ EJECT button

- Press this to eject the disc. The EJECT button is locked when Eject Lock is on in the preset menu and the unit is in PLAY mode.

**⑥ Display unit**

- Refer to page 5 for details.

**⑦ Remote control sensor****⑧ SHIFT button**

- Press and hold while you press other controls to activate alternate functions.

**⑨ MENU/STORE button**

- Press to enter the preset menu or to store changes in the preset menu.

**⑩ DISPLAY/LOCK button**

- Press this to change the time mode on the display.
- Press this button while pressing the SHIFT button to lock or unlock the controls on the front panel.

**⑪ PITCH button and indicator (Amber)**

- Press this button to switch the PITCH on or off.

**⑫ A-B/REPEAT button**

- Use this to play a set section repeatedly. When the button is pressed once during playback, that position is set as the A point and the "A-" indicator flashes on the display.
- When the button is pressed again, that position is set as the B point, the "A-B" indicator stops flashing (remaining lit), and the A-B section begins playing repeatedly.
- When the button is pressed again, A-B repeat is canceled and the mode returns to the normal play mode.
- Press this button while pressing the SHIFT button to select the repeat mode.

**⑬ PLAY MODE/TEXT button**

- Press this button to select the play mode.
- Press this button while pressing the SHIFT button to display the text information.

**⑭ ⑮ ◀ ▶ / - INDEX/DIR + button**

- These buttons are used to accurately change the positions where playback will start or operate as FF or FR when held down.
- Use this button while pressing the SHIFT button to select the index (Audio CDs) or directory (music file discs).

**⑯ ■ /CANCEL button**

- Press this button to stop playback.
- Press this to cancel a selection in program setting.
- During preset setting operations, press to cancel all entries made and return to stop mode.

**⑰ SKIP BACK button**

- Press this button for instant replay at the currently playing audio. The amount of time skipped back is adjustable in the preset menu.

**⑱ CUE button and indicator (Amber)**

- When pressed during playback, the pickup returns to the position at which playback last started or the next track and the CUE mode is set.
- When pressed during manual search, the CUE mode is set at that position.

**⑲ ▶ / II /END MON button and indicator (Green)**

- Use this button to start playback or pause playback. (play or pause button)
- Press this button while pressing the SHIFT button to start the End Monitor.

**⑳ Jog wheel with PUSH/ENTER button**

- Turn the jog wheel clockwise by one click to move one track forward, counterclockwise by one click to move one track backward.
- In the preset mode, turn the jog wheel to select the preset item and push to enter.
- Use this jog wheel while pressing the SHIFT button to set the pitch value.
- In the stop mode or in the play/pause mode, push this to start playback.

# 1. GENERAL INFORMATION

## (2) Rear panel

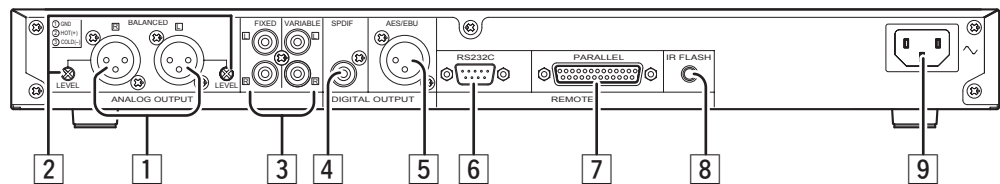

### 1 ANALOG (Balanced) OUTPUT

- These are active balanced outputs using XLR type connections. The CD's audio playback signals are output from these connectors.
- Pin layout : 1. GND / 2. Hot / 3. Cold
- Applicable connector :  
Cannon XLR-3-31 or equivalent.

**NOTE :**

- Do not short-circuit the hot or cold pin with the common pin.

### 2 LEVEL Control

- Use these controls to adjust the level of the audio signals from the BALANCED OUT connectors.

### 3 ANALOG (Unbalanced) OUTPUT

- These are unbalanced outputs using RCA type jacks.
- VARIABLE  
Use the remote control unit or web GUI to adjust the output level.

### 4 DIGITAL (SPDIF) OUTPUT

- This is a coaxial output using an RCA type jack.
- Signal format : SPDIF(IEC-958 Type II) Only

### 5 DIGITAL (AES/EBU) OUTPUT

- This is a balanced output using an XLR type jack.  
1.Common / 2.Hot / 3.Cold.
- Signal format : SPDIF Only
- Applicable connector: cannon XLR-3-31 or equivalent

**NOTE :**

- Do not short-circuit the hot or cold pin with the common pin.

### 6 RS232C connector

Connector for serial control from an external device.

### 7 PARALLEL connector

Connector for parallel control from an external device.

### 8 IR FLASH (RC In Control) Jack (1/8" stereo mini jack)

Basic functions can be controlled.  
PLAY, PAUSE, CUE,FWD, FF, SKIPBACK, TRACK JUMP-, TRACK JUMP+, STOP.

### 9 AC inlet

Connect the included power cord here.

**(3) Display**

Specific Icons and Character displays inform you of the current operating status and menu items of the device.

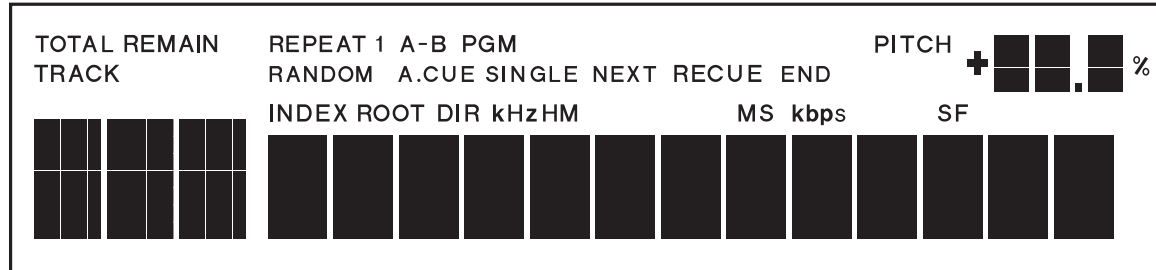

**[Basic CD Operation]**

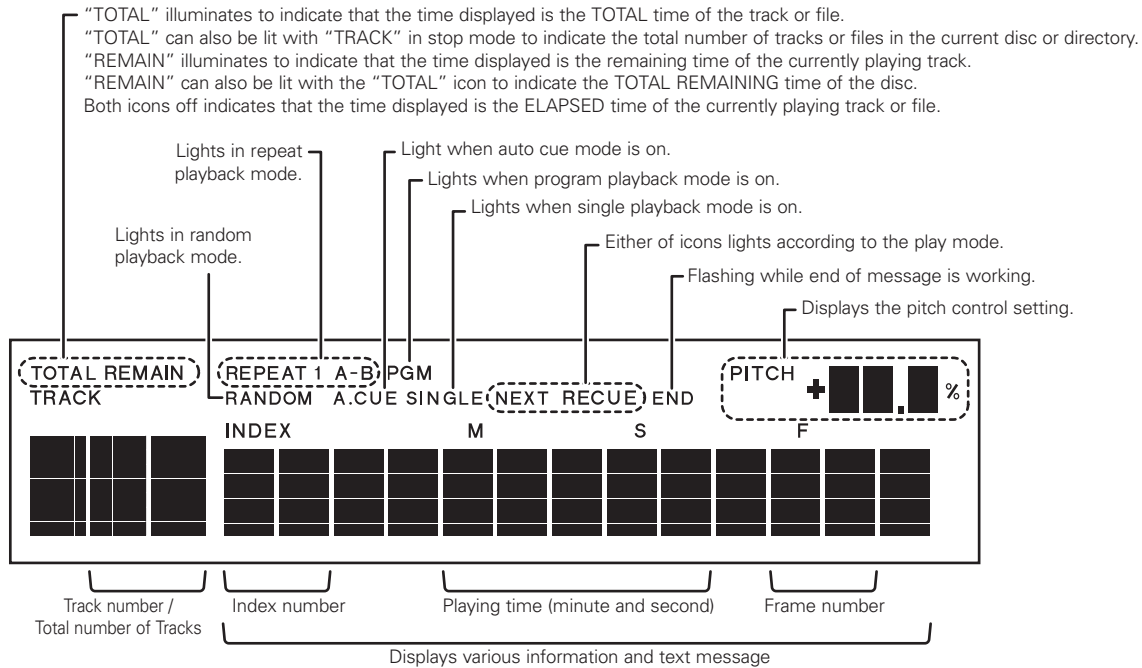

# 1. GENERAL INFORMATION

## [Audio file Operation]

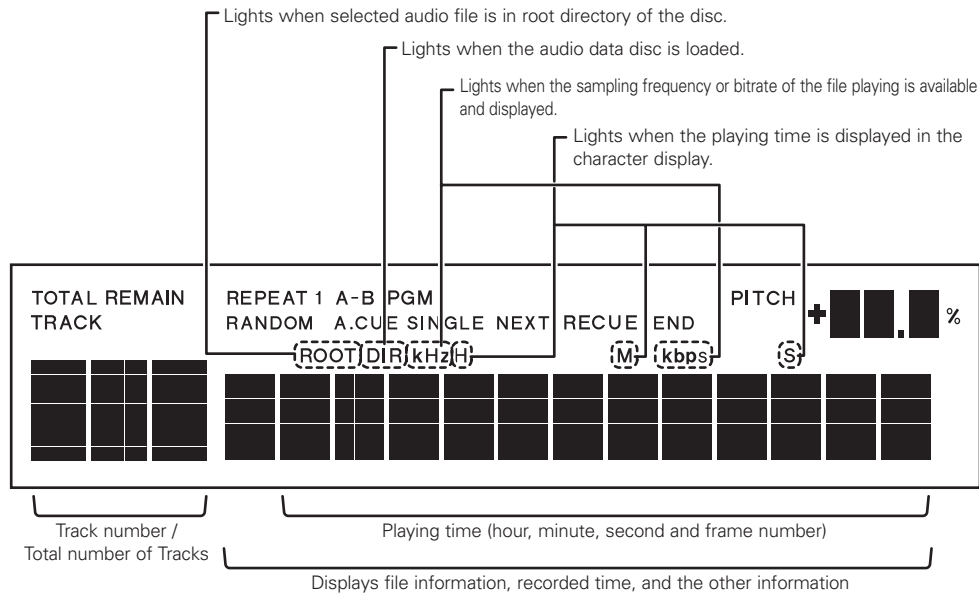

## (4) Remote control unit (RC-1061)

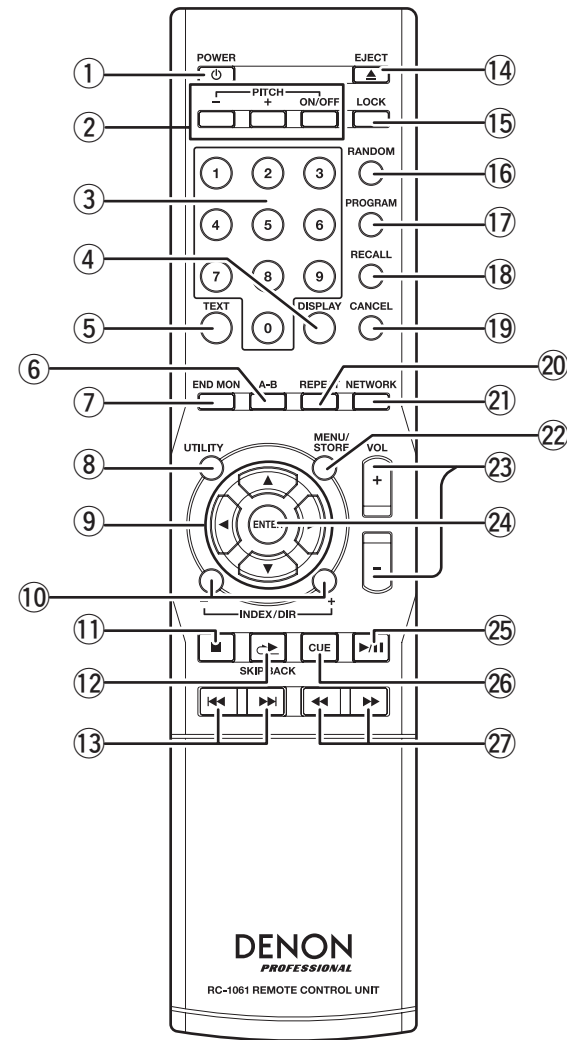



- ① **POWER button**  
Press this to turn the power on or off.
- ② **PITCH +/- buttons**  
Press these buttons to adjust the Pitch up(+) or down(-).  
**PITCH ON/OFF button**  
Press this to turn the pitch control function on or off.
- ③ **0-9 buttons**  
Press these to select the desired track in the stop mode.
- ④ **DISPLAY button**  
Press this to change the time mode on the display.
- ⑤ **TEXT button**  
Press this to display the CD Text or ID3 tag information.
- ⑥ **A-B button**  
Press this to set or cancel the A-B repeat function.
- ⑦ **END MON button**  
Press this to start the End Monitor function.
- ⑧ **UTILITY button**  
This button is invalid for the DN-C620.
- ⑨ **▲ / ▼ / ◀ / ▶ buttons**  
Use these for menu selection and ◀ / ▶ for track selection.
- ⑩ **INDEX +/- buttons**  
Press this to select the index (Audio CDs) or directory (Audio data discs).
- ⑪ **STOP button**  
Press this to stop the playback.
- ⑫ **SKIP BACK button**  
Press this for instant replay of the currently playing audio.
- ⑬ **◀◀ / ▶▶ buttons**  
Press these to skip from track to track or file to file.
- ⑭ **EJECT button**  
Press this to eject the disc.
- ⑮ **LOCK button**  
Press this to lock or unlock the buttons on the front panel.
- ⑯ **RANDOM button**  
Press this to set the random playback mode.
- ⑰ **PROGRAM button**  
Press this to enter the program mode.
- ⑱ **RECALL button**  
Press this to recall the programmed track.
- ⑲ **CANCEL button**  
Press this to cancel a selection in program setting.
- ⑳ **REPEAT button**  
Press this to set repeat playback.
- ㉑ **NETWORK button**  
This button is invalid for the DN-C620.
- ㉒ **MENU/STORE button**  
Press this to enter the preset menu or to store changes made in the preset menu.
- ㉓ **VOL +/- buttons**  
Press these to change the playback volume output through the unbalanced VARIABLE Output jacks.
- ㉔ **ENTER button**  
Press this to confirm selections in the menus.
- ㉕ **▶ / || button**  
Press this to start playback or pause playback.
- ㉖ **CUE button**  
Press this to return to the position at which playback started or the next track.
- ㉗ **◀◀ / ▶▶ buttons**  
Press this to accurately change the positions where playback will start or operate as FF or FR when held down.

## 1. GENERAL INFORMATION

### • Operational range

As shown in the figure below, the player can be operated by the remote control unit in a range which of about 5 meters from the player's remote sensor and over an angle up to 30 degrees to the left and 30 degrees to the right of the position directly in front.

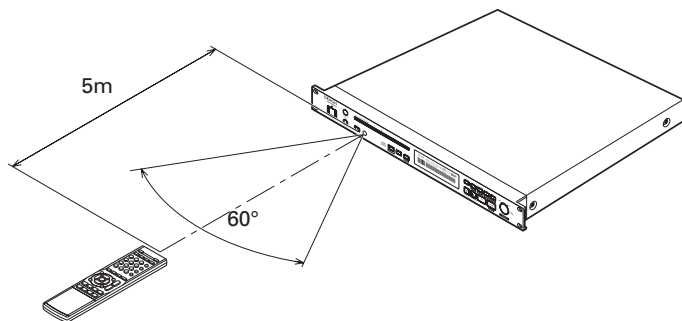

### • Loading batteries

Before using the supplied remote control unit for the first time, load the batteries in the remote control unit. The batteries provided are used to verify the operations of the remote control unit only.

1. Take hold of the tab on the battery cover which is found on the back side of the remote control unit, and pull it up.

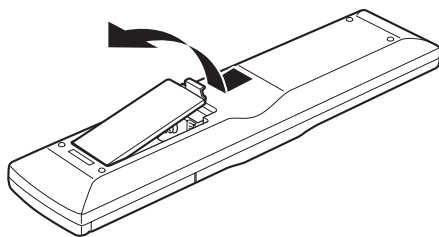

2. Load the two new size "AAA" batteries inside the battery compartment while taking care to align their polarities correctly with the polarity markings (+ with + and - with -).

Size "AAA" (UU-4) batteries × 2

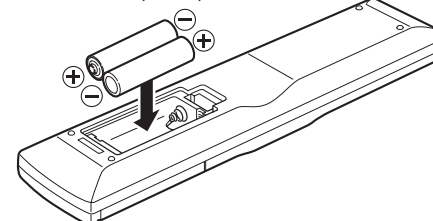

3. Push the battery cover down in the direction of the arrow to close it.

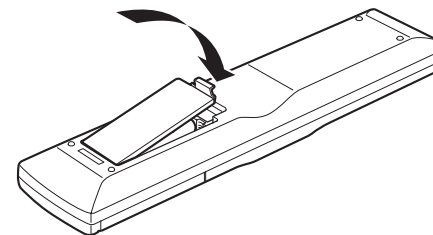

### CAUTION:

Misuse of the batteries can result in electrolyte leakage, rupturing, corrosion, etc.

Bear in mind the following points when using batteries.

- Remove the batteries from the remote control unit if the unit is not going to be used for a prolonged period (a month or more).
- Do not use an old battery together with a new one.
- Insert the batteries while ensuring that their + and - poles are properly aligned with the corresponding markings on the remote control unit.
- Batteries with the same shape may have different voltages. Do not use different types of batteries together.
- If electrolyte has leaked, thoroughly wipe the inside of the battery compartment, and then insert new batteries.

## 2. PREPARATIONS

### INSTALLATION

#### ■ Mounting in a rack

- The DN-C620 is of 1U size, allowing it to be mounted in EIA standard 19-inch racks. When mounting the DN-C620 in a rack, use guide rails or shelf boards, etc., on the rack side to prevent weight from being applied to the front of the DN-C620. The fittings alone cannot support the weight of the DN-C620 (4.3 kg). Do not cover the top of the unit. Remember, heat is dispersed from the DN-C620's upper surface.
- Set up the installation environment carefully. For example, take care to protect the DN-C620 from heat from other devices. If necessary, use forced ventilation. The surrounding conditions must meet the specifications described in "SPECIFICATIONS" on Page 43.
- The DN-C620 will work normally when the player unit is mounted with the front panel within 10 degrees of the vertical plane. If the unit is tilted excessively, discs may not load or unload properly.

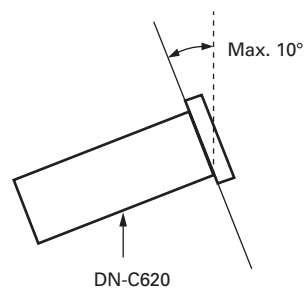

- If the DN-C620 is placed near an amplifier, tuner or other components, noise (induced hum) or beat interference may result (especially during AM or FM reception). If this occurs, separate the DN-C620 from other components or reorient its position.

## 2. PREPARATIONS

### CONNECTIONS

Leave your entire system (including the DN-C620) turned off until all connections between the DN-C620 and other components have been completed.

#### ■ Connection precautions

- Before proceeding with connections or disconnections of cables and power cords, be sure to turn all system components off.
- Ensure that all cables are connected properly to the L (left) and R (right) jacks.
- Insert plugs fully into the terminals.
- Connect the CD output jacks to the amplifier CD or AUX input jacks.
- Connect one end of a straight-through RS-232 serial cable into Communication Port on the back of the DN-C620 and connect the other end into the "RS-232C" port on the back of the computer.

#### ■ Basic connection

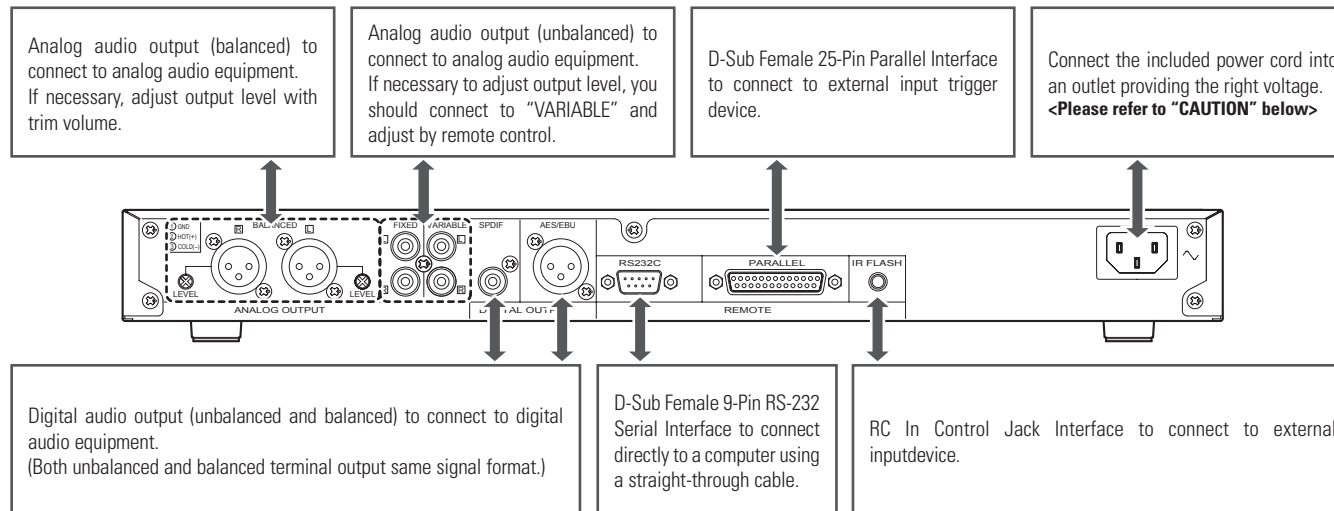



#### CAUTIONS:

- Before connecting, the POWER ON/OFF switch should be set the OFF position.
- Do not touch the power cord with wet hands.
- When disconnecting the power cord, always make sure that you take hold of the plug. Yanking out or bending the cord can damage it and/or cause electric shocks or a fire.

### 3. DEVICE OPERATION

#### SUPPORTED AUDIO CD

In addition to standard CD-DA discs, the DN-C620 can read several other CD-DA formats. Please refer to page 22 for detail of reading and operation of data discs.

Compact Disc Digital Audio (CD-DA)	
Compact Disc TEXT (CD TEXT)	
Enhanced Music CD (CD EXTRA)	

**NOTE:**

- Some copy-controlled CDs may not conform to official CD standards. They are special discs and may not play on the DN-C620.

#### INSERTING AND EJECTING A DISC

Inserting and Ejecting a disc is only available when the unit is powered on.

1. If the unit is OFF, press the **POWER ON/OFF** switch to turn on the power.
2. Hold the disc by the edges and insert it in the DISC slot.  
(Do not touch the signal surface, i.e., glossy side.)
3. Press the **EJECT** button to eject the disc.

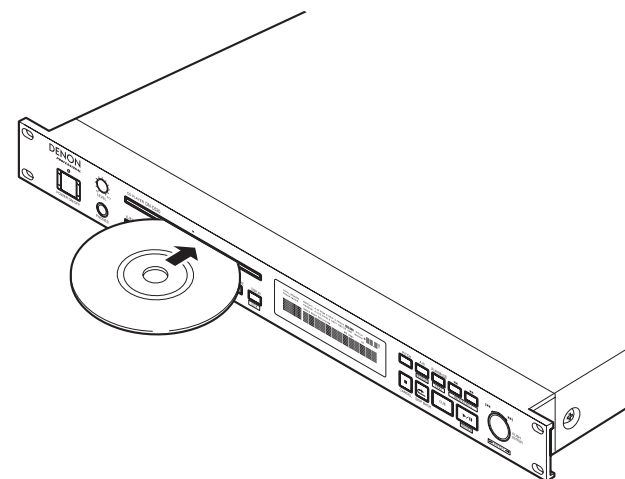

■ **Messages**

Messages may appear on the display while using the DN-C620. The meanings of the messages are explained below.

Message	Meaning
No Disc	No disc is inserted.
Eject Locked	Unit is playing and Eject lock is on in the preset menu.

**CAUTIONS:**

- Do not push in the disc manually when the power is off as this may cause malfunction and damage the CD player.

### 3. DEVICE OPERATION

## NORMAL CD PLAYBACK

### (1) Before Starting Playback

1. Press the **POWER ON/OFF** switch to turn on the power.

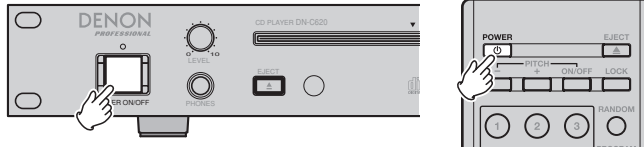

2. Load the disc you want to play.
3. Make sure the Preset Menu settings are set accordingly for the intended use. (See Page 25.)

### (2) Starting Playback

1. Press the **▶ / || / END MON** button on the front panel or the **▶ / ||** button on the remote control unit.

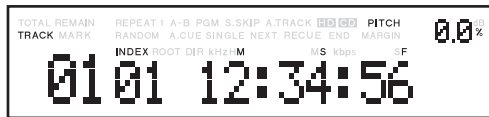
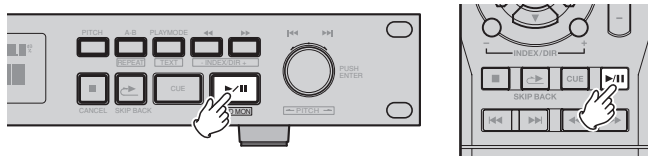

### (3) Pausing playback at any point

Playback can be temporarily halted and then continued from the same point in the track.

1. Press the **▶ / || / END MON** button on the front panel or the **▶ / ||** button on the remote control unit during playback. (Button Flashes when in PAUSE mode)

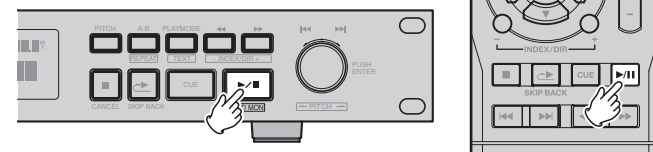

2. To continue playback, press the **▶ / || / END MON** button on the front panel or the **▶ / ||** button on the remote control unit.

### (4) Returning to the position at which playback started

Set the CUE mode to RECUE in the preset menu and press the **CUE** button during playback, the pickup returns to the position at which playback started and the pause mode is set.

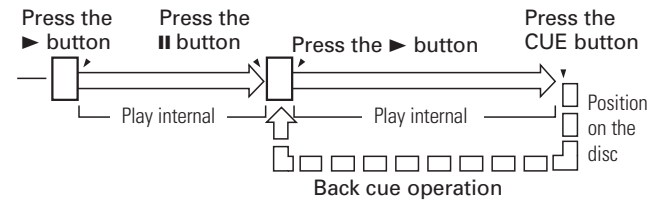
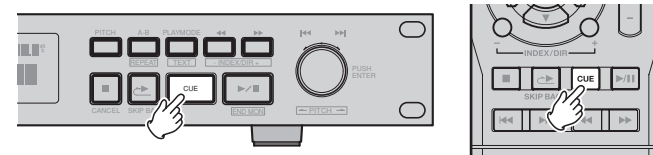

### (5) Stopping playback

1. Press the **STOP/CANCEL** button.

**(6) Advancing to the next track during playback**

1. Turn the **jog wheel** clockwise or press the ►► button during playback.



- The pickup will advance to the beginning of the next track and playback will continue when the Start mode is set to "Play" in the preset menu.
- The pickup will advance to the beginning of the next track and remain in CUE mode when the Start mode is set to "Stop" or "Cue" in the preset menu. (See Page 27 for Start Mode Settings)

**NOTE:**

- When the Next track reserve mode is set to "ON" in the preset menu, if you turn the **jog wheel** during playback, the track number indication of the display will blink and you can select the track to play next.

**(7) Returning to the beginning of the current track during playback**

1. Turn the **jog wheel** counterclockwise or press the ◀◀ button during playback.



- The pickup will return to the beginning of the current track and playback will continue when the Start mode is set to "Play" in the preset menu.
- The pickup will return to the beginning of the current track and remain in CUE mode when the Start mode is set to "Stop" or "Cue" in the preset menu.

**NOTE:**

- When the Next track reserve mode is set to "ON" in the preset menu, if you turn the **jog wheel** during playback, the track number indication of the display will blink and you can select the track to play next.

**(8) Audible quick search**

- Using this function, you can search for a desired point quickly within a track in the both forward or reverse direction.
- When a **SEARCH** button is pressed during the pause mode and the button is released, the pause mode is cancelled at that point with the sound being output.

**Manual search forward**

1. Press the **SEARCH** (►►) button during playback.

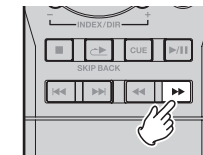
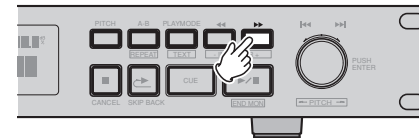

- The playback mode is cancelled, and the search point is reproduced repeatedly.
- Every time the **SEARCH** (►►) button is pressed the playback point advances one frame.
- Playback of the track is sped up while the **SEARCH** (►►) button is pressed.

**Manual search in reverse**

1. Press the **SEARCH** (◀◀) button during playback.

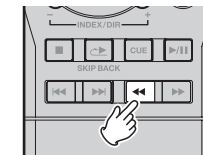
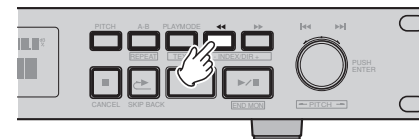

- The playback mode is cancelled, and the search point is reproduced repeatedly.
- Every time the **SEARCH** (◀◀) button is pressed the playback point retreats one frame.
- Playback of the track is sped up while the **SEARCH** (◀◀) button is pressed.

### 3. DEVICE OPERATION

#### (9) Index Skip

An index search can be performed during the play of a track whose index has been recorded. This function is useful for starting play at a specific location of a long track. It returns play to a previous index which is equivalent to the number of times the INDEX – button on the unit or IR control was pressed; alternatively, it advances play to a subsequent index which is equivalent to the number of times the INDEX + button on the unit or IR control was pressed. If the index skip function is operated for a CD with no indexes recorded, the “No Index” message appears on the main display, and play returns to the start of the track now playing.

#### NOTE:

- The index skip function cannot be used for discs recorded with audio files. In that instance, the index button navigate directories.

#### (10) Direct Jump

Select the number of the track to be played directly during the stop mode by pressing the numeric buttons (0 to 9) on the remote control unit.

To select track number 10 or above, use the numeric buttons to select the higher digit first and then select the lower digit.

The operation after the number of the track is selected depends on the start mode settings.

#### Example: To play track 12

1. Set the start mode to “Play”.
2. Press the “1” numeric button.

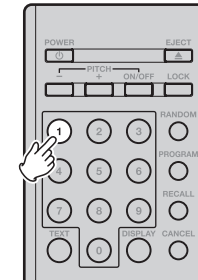

3. Within 1 second, press the “2” numeric button.

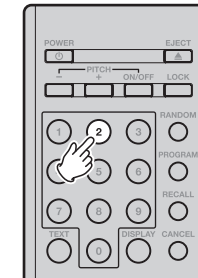



## ADVANCED CD PLAYBACK

### (1) Repeating playback of a desired interval

#### (Single track repeat)

1. Press the **PLAY MODE/TEXT** button to select “Single Stop”, “Single Next” or “Single Recue”.
2. Press the **A-B/REPEAT** button on the front panel while pressing the **SHIFT** button.

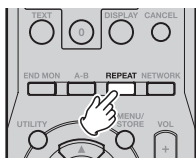

- The “REPEAT 1” indicators light on the display and the single track repeat mode is set.
3. Use the select knob to select the track to be played repeatedly.
  4. Press the **▶ / || / END MON** button on the front panel or the **▶ / ||** button on the remote control unit.

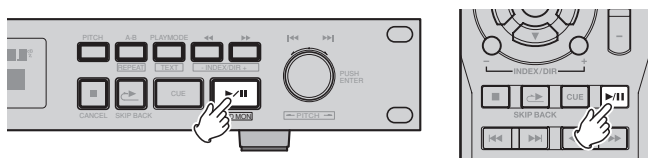

- Playback starts.
- Once the selected track ends, it is played again from the beginning.
- The single track repeat mode can also be set by pressing the **A-B/REPEAT** button on the front panel while pressing the **SHIFT** button during playback. The current track is played repeatedly.
- To cancel the single track repeat mode, press the **A-B/REPEAT** button on the front panel while pressing the **SHIFT** button repeatedly until the “REPEAT 1” indicator turns off.

#### (All track repeat)

1. Press the **PLAY MODE/TEXT** button to select “Continuous”.
2. Press the **A-B/REPEAT** button on the front panel while pressing the **SHIFT** button.

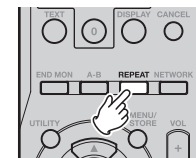

- The “REPEAT” indicators light on the display and the all track repeat mode is set.
3. Press the **▶ / || / END MON** button on the front panel or the **▶ / ||** button on the remote control unit.

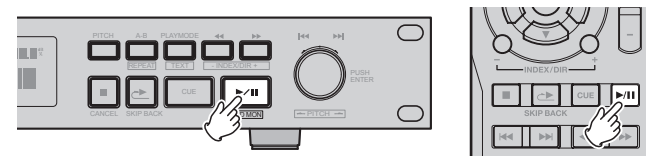

- The disc is played repeatedly.
- The all track repeat mode can also be set by pressing the **A-B/REPEAT** button on the front panel while pressing the **SHIFT** button during playback.
- If the repeat function is activated during program play, the tracks are played repeatedly in the programmed order.
- To cancel the all track repeat mode, press the **A-B/REPEAT** button on the front panel while pressing the **SHIFT** button repeatedly until the “REPEAT” indicator turns off.

### 3. DEVICE OPERATION

#### (2) Repeating playback a specific section within a track

##### (A-B repeat)

1. During playback, press the **A-B** button at the point where you want to start repeated playback (A point).

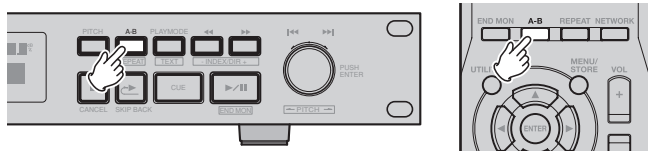

- The "A-" indicator flashes on the display.
2. Press the **A-B** button again at the point where you want to end repeated playback (B point).
    - The "A-B" indicator stops flashing (remaining lit), and the A-B section begins playing repeatedly.
    - If no B point is set before the current track ends, the end of the track is set as the B point.
  3. To cancel A-B repeat playback, press the **A-B** button again.

##### NOTE:

- The A-B points must be separated by at least 1 seconds time to work.

#### (3) Playing specific tracks in a specific order (Program play)

With this function, you can choose any of the tracks on the disc and program them to play in any order. Up to 99 tracks can be programmed.

##### Creating the program

1. Press the **PROGRAM** button on the remote control unit.

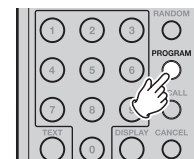

- The "PGM" indicator flashes, and the program number and track number are shown on the display.
2. Press the **◀** or **▶** button on the remote control unit to select the first track of the program.
  3. Press the **ENTER** button on the remote control unit to select the track.

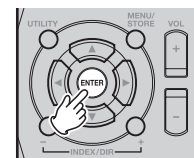

- Skip to the next desired track and press the **ENTER** button again.
  - Repeat steps 2 and 3 to program the tracks in the desired order.
4. Press the **PROGRAM** button to exit the program input mode.
    - "PGM" indicator lights, and the DN-C620 is ready to play your program.

**Editing the program**

1. Press the **RECALL** button on the remote control unit while the "PXX" is displayed.

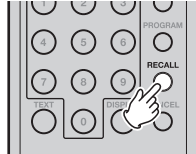

2. Press the **UP** or **DOWN** button on the remote control unit to select the program number you want to edit.

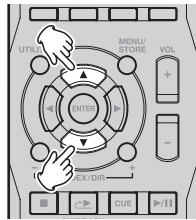

3. Press the **◀◀** or the **▶▶** button on the remote control unit to select the track of the program number.
4. Press the **CANCEL** button on the remote control unit to delete a track in the program.

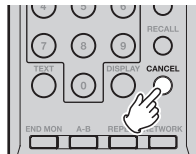

5. Press the **ENTER** button on the remote control unit to add a track.

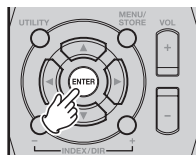

- To enter the next track, press the **ENTER** button again.
- Repeat steps 2 and 3 to program the tracks in the desired order.

6. Press the **PROGRAM** button to exit the program edit mode.

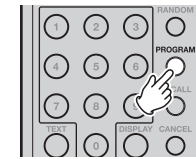

- "PGM" indicator lights, and the DN-C620 is ready to play your program.

**Playing the programs**

1. Press the **PLAY/PAUSE** button.

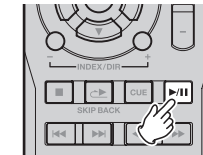
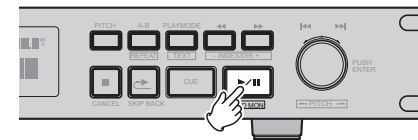

- Program play starts.

**Exit the program mode**

1. Press the **PROGRAM** button.
  - "PGM" indicator turns off.
  - The program is also cleared when the EJECT button is pressed.



**(7) Play Mode**

Play Mode lets you choose what happens when the end of a track is reached during playback.

Set Value	Description
Continuous (Default)	When playback reaches the end of a track it automatically begins the next track until all tracks have been played.
Single Next	The unit advances to the next track and waits in Cue Mode.
Single ReCue	The unit returns to the beginning of the current track and waits in Cue Mode.
Single Stop	The unit returns to stop mode after the track has played.
Random	The unit plays all the tracks in random sequence.

**(Continuous)**

1. Press the **PLAY MODE/TEXT** button on the front panel.
  - The “Continuous” is displayed on the display and the continuous mode is set.
2. Use the select knob to select the track to be played.
3. Press the **▶ / || /END MON** button on the front panel or the **▶ / ||** button on the remote control unit.

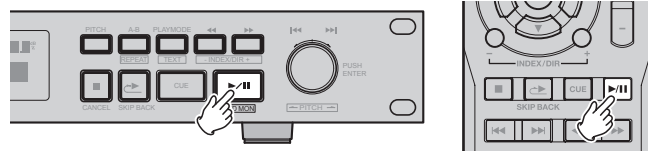

- Playback starts.
- When playback reaches the end of a track it automatically begins the next track until all tracks have been played.
- After the last track ends, playback stops. The DN-C620 returns to stop mode.

**(Single Next)**

1. Press the **PLAY MODE/TEXT** button on the front panel.
  - The “Single Next” is displayed on the display and the Single Next mode is set.
2. Use the select knob to select the track to be played.
3. Press the **▶ / || /END MON** button on the front panel or the **▶ / ||** button on the remote control unit.

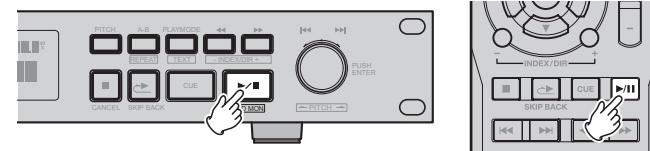

- Playback starts.
- When the playback reaches the end of a track the unit advances to the next track and waits in Cue Mode.

**(Single Recue)**

1. Press the **PLAY MODE/TEXT** button on the front panel.
  - The “Single Recue” is displayed on the display and the Single Recue mode is set.
2. Use the select knob to select the track to be played.
3. Press the **▶ / || /END MON** button on the front panel or the **▶ / ||** button on the remote control unit.

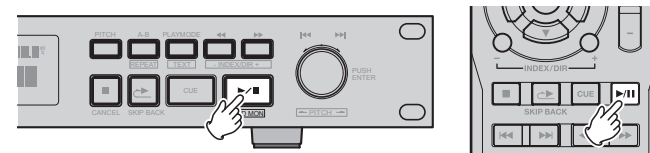

- Playback starts.
- When the playback reaches the end of a track the unit returns to the beginning of the current track and waits in Cue Mode.

### 3. DEVICE OPERATION

#### (Single Stop)

1. Press the **PLAY MODE/TEXT** button on the front panel.
  - The “Single Stop” is displayed on the display and the Single Stop mode is set.
2. Use the select knob to select the track to be played.
3. Press the **▶ / || / END MON** button on the front panel or the **▶ / ||** button on the remote control unit.

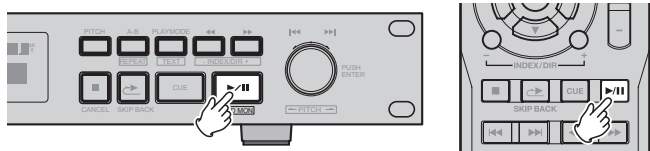

- Playback starts.
- When the playback reaches the end of a track the unit returns to stop mode.

#### (Random)

1. Press the **PLAY MODE/TEXT** button on the front panel.
  - The “Random” is displayed on the display and the Random playback mode is set.
2. Press the **▶ / || / END MON** button on the front panel or the **▶ / ||** button on the remote control unit.

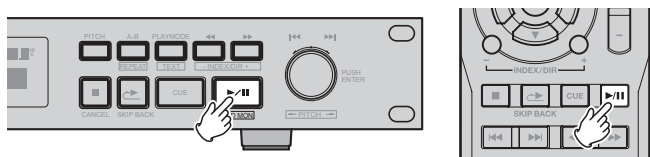



- Playback starts.
- The unit plays all the tracks in random sequence.

## PLAYING AUDIO FILES

In addition to standard CD-DA discs, the DN-C620 can read audio files from two different types of Data discs. For a list of compatible compressed and uncompressed audio files, see following section: Audio File Format Specifications.

### ■ Supported data discs

Compact Disc Recordable (CD-R)	
Compact Disc ReWritable (CD-RW)	

#### NOTE:

- The DN-C620 supports following file system for the data discs.  
ISO9660 Level1 and Level2, Joliet, UDF version 1.50 and 2.00
- The DN-C620 cannot read unfinalized CD-R disc.
- The DN-C620 can only read the 1st session of a multi-session disc.
- There are the following conditions in the data discs that can be read.
  - Maximum number of directories: 254
  - Maximum number of files: 999  
If there are more than 1,000 files, only the first 999 files are played.
  - Folder layers: 8 layers, including root
- The DN-C620 does not support two byte character sets.

### ■ Audio file format specifications

The DN-C620 supports PCM, MP3 audio formats.

	File Extension	System	Sample Rate	Bit Rate	Resolution
PCM	wav	16-Bit Linear PCM	48kHz, 44.1kHz, 32kHz	–	16-bit
MP3	mp3	ISO/IEC11172-3 MPEG1- L3	48kHz, 44.1kHz, 32kHz	32 kbps – 320 kbps	16-bit

### 3. DEVICE OPERATION

#### ■ Functions not supported by playing audio file

The following functions are not supported when the DN-C620 encounters discs recorded with these types of audio files.

- Index skip function is not available.
- Playback of half-rate audio files MPEG2-L3 (24 kHz, 22.05 kHz, 16 kHz) is not available.
- If an audio file includes content protection, it may not be played.

#### ■ Handled audio files as “track” and playing audio file

A directory (also called a “folder”) is a hierarchical level on disc media.

After loading a data disc and searching all audio files, the DN-C620 assigns each audio file a track number.

Only the files within the selected directory will be the target of your operations, and functions such as program playback and repeat playback will all occur within the same directory.

For example in the illustration below, at first each audio file is assigned a track number. Directory-AAA, directory-BBB and directory-DDD contain audio files and can be selected for operations, but directory-CCC is excluded from operations.

If directory-AAA is selected, CD operations such as program playback are effective only to audio files of directory-AAA, it means aaa001.mp3/track# 003 and bbb001.mp3/track# 004 are effective for operation.

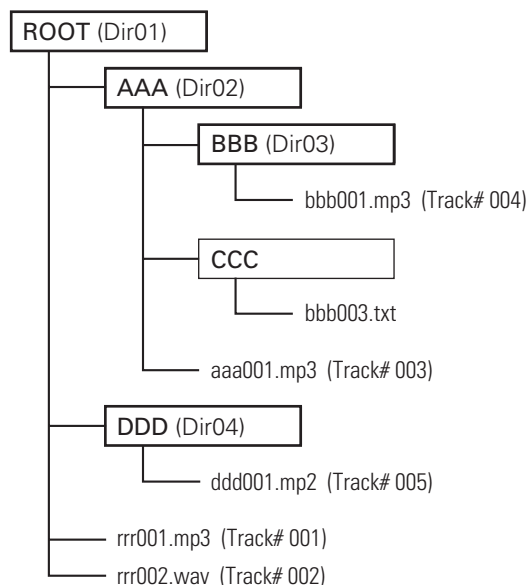

#### ■ Displays information

When a data disc is inserted into the DN-C620, various kind of information are displayed on the 13-digit alphanumeric part of the display unit.

When in play, pause, search, end mon. or cue state, the following information is displayed in order by pressing the **DISPLAY/LOCK** button.

- Elapsed time  
↓
- Remaining time  
↓
- File name  
↓
- File information  
↓ : sample frequency, bit rate or resolution, and file format (PCM, MP3)
- Recorded date  
↓ : year, month and day. [MMMD DD YYYY]
- Recorded time  
↓ : hour, minute and second. [HH:mm:SS]
- Channel  
↓ : “Stereo” or “Mono”



### ■ Text information

When a data disc with MP3 files, is inserted into the DN-C620, in addition to above information various kind of text information are displayed on the 13-digit alphanumeric part of the display unit. This information is recorded in a MP3 file as ID3 tag.

When in play, pause, search, end mon. or cue state, the following information is displayed in order by pressing the **PITCH/TEXT** button with the unit in SHIFT mode.

– [Above information]



– Title



– Artist



– Album

**NOTE:**

- Only standard ID3 information that has been accurately recorded in the file will be displayed.

### 3. DEVICE OPERATION

#### (1) Playing audio files on a disc

1. Load a disc containing audio files.



- The display will change to "Loading.". When the contents of the disc have been read, the total number of tracks will be displayed.
2. Turn the **jog wheel** to select a file you want to listen to.
    - The file name scrolls and back to the number of track on the display.
  3. Press the **▶ / || / END MON** button.



#### (Directory skip)

1. In shift mode, press the **INDEX/DIR +/-** button to select a folder.
  - The display will indicate each name of all folders including sub-folders.
2. Press the **▶ / || / END MON** button.
  - Playback will be started from the top file within the selected folder.

#### (2) Advanced music files playback

The following "Advanced CD playback" functions are possible with audio files on a disc in the same way as a standard CD-DA disc.

See page 16 for detail of an operation.

- **Single track repeat**
- **All track repeat**
- **A-B repeat**
- **Program play**
- **Pitch control**
- **Skip back**
- **End monitor**

## PRESET FUNCTIONS AND OPERATIONS

### (1) Changing the PRESETS

#### [ Using the front panel ]

1. With the unit in stop mode, press the **MENU/STORE** button.

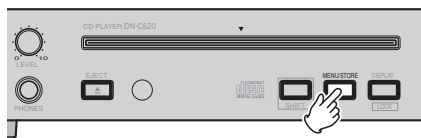

The last active preset item appears on the display.

2. Turn the **jog wheel** to select the preset item you wish to modify.
3. Press the **jog wheel** to confirm your selection.  
Preset setting data appears on the display. You will now be able to edit the preset item.  
For details of each preset item, see page 27.
4. Turn the **jog wheel** to adjust the parameters for that item.  
Press the **jog wheel** to confirm your setting/action.  
Repeat steps 2-4 as needed.
5. Press the **MENU/STORE** button to save changes or **STOP/CANCEL** button to cancel all changes and return to stop mode.

#### [ Using the remote control unit ]

1. With the unit in stop mode, press the **MENU/STORE** button.  
The last active preset item appears on the display.

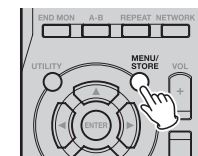

2. Press the **▲** button or the **▼** button to select the preset item you wish to modify.
3. Press the **ENTER** button to confirm your selection.  
Preset setting data appears on the display. You will now be able to edit the preset item.  
For details of each preset item, see page 27.

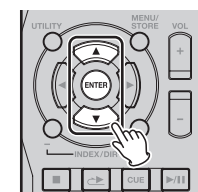

4. Press the **▲** button or the **▼** button to adjust the parameters for that item.  
Press the **ENTER** button to confirm your setting/action.  
Repeat steps 2-4 as needed.
5. Press the **MENU/STORE** button to save changes or **STOP** button to cancel all changes and return to stop mode.

### 3. DEVICE OPERATION

#### (2) Table of Preset Items and Default settings

No (Order)	Display (Preset item)	Selection Range	Default	Reference
1.	Power On	Play /Stop	Stop	Page 27
2.	Start Mode	Play /Stop /Cue	CUE	Page 27
3.	Cue Mode	Recue /Next	Recue	Page 27
4.	Auto Cue	Off /-48dB /-42dB /-36dB	Off	Page 27
5.	Fade In	Off /0.5sec - 10.0sec (0.5second steps)	Off	Page 28
6.	Fade Out	Off /0.5sec - 10.0sec (0.5second steps)	Off	Page 28
7.	Skip Back	1.0 – 30.0 sec (0.5 second steps)	10.0	Page 28
8.	End Monitor	5 /10 /15 /20 /25 /30 /35 sec	10	Page 28
9.	EndOfMessage	Off /0 /5 /10 /15 /20 /30 /60 sec	10	Page 29
10.	NextTrReserve	On /Off	Off	Page 29
11.	Fader Start	Play /Play-Pause	Play-Pause	Page 30
12.	Index Tally	Index2 /Index3	Index2	Page 30
13.	Mono	On /Off	Off	Page 30
14.	Auto Sleep	OFF /30sec /10 min /20 min /30min	30 min	Page 30
15.	Eject lock	On /Off	On	Page 31
16.	F/W Version	Displays the units FW version	-	Page 31
17.	Default	-	-	Page 31

**(3) Detailed description of the Preset items**1. **Power on playback** (Power On)

This feature allows you to decide the status of the unit after the TOC has been read or the DIR structure has been identified.

Set value	Description
Play	Unit starts to play after boot procedure is completed
Stop (default)	Unit sits in stop mode after boot procedure is completed

2. **Start mode** (Start Mode)

This feature allows you to decide what the DN-C620 will do after a track is selected with the track search operation.

Set value	Processing	
	Inserting a new disc	Switching tracks or index points
Play	Unit starts playback at the first track of the disc	Unit starts to play the desired track or index or file
Cue (default)	Unit cues to the first track of the disc	Unit Cues to the selected track or index or file
Stop	Unit sits in stop mode	Unit Cues to the selected track or index or file

3. **Cue mode** (Cue Mode)

This feature allows you to decide what the DN-C620 will do when the CUE button is pressed.

Set value	Processing
Recue (default)	Unit returns to the previously cued start position of the currently playing file
Next	Unit cues to the next track

4. **Auto Cue** (Auto Cue)

This feature allows you to decide at what level of music the DN-C620's Auto Cue feature will detect.

Set value	Processing	
	Auto Cue	Detecting level is less than
Off (default)	Off	—
-48dB	On	-48dB
-42dB	On	-42dB
-36dB	On	-36dB

**NOTE:**

- If an audio signal isn't detected within the maximum period of time (20 seconds) then the DN-C620 will most likely Cue to the beginning of index 01.

### 3. DEVICE OPERATION

5. **Fade in time** (Fade In)

This feature allows you to adjust the length of time for the DN-C620's Fade In feature.

Set value	Processing	
	Fade in	Fade in time
Off (default)	Off	—
0.5sec – 10.0sec (0.5second step)	On	0.5second – 10.0seconds

6. **Fade out time** (Fade Out)

This feature allows you to adjust the length of time for the DN-C620's Fade Out feature.

Set value	Processing	
	Fade out	Fade out time
Off (default)	Off	—
0.5sec – 10.0sec (0.5second step)	On	0.5second – 10.0seconds

7. **Skip back time** (Skip Back)

This feature allows you to set the amount of time that the DN-C620 will instantly replay when SKIP BACK is pressed on the unit or IR control.

Set value	Processing	
	Skip Back time	
1.0sec – 30.0sec (Default 10.0sec) (0.5second step)	1.0second – 30.0seconds	

8. **End monitor time** (End Monitor)

This feature allows you to set the amount of time at the end of the track that the DN-C620 will play when the END MON button is pressed on the unit or IR control while in standby. In the MP3 play mode, the time of monitor may not be correctly.

Set value	Processing	
	End Monitor time	
5sec – 35sec (Default 10sec) (5seconds step)	5seconds – 35seconds	

9. **End of message time** (EndOfMessage)

This feature allows you to set the amount of time at the end of the track where the End of Message will be displayed. When less than the user selected time is left at the end of the currently playing track, the "END" on the display will begin to flash until the track has completed.

Set value	Processing	
	End of Message	End of Message time
Off	Off	—
0/ 5 /10 /15 /20 /30 /60sec (Default 10sec)	On	0/ 5 /10 /15 /20 /30 /60seconds

10. **Next track reserve** (NextTrReserve)

This feature allows you to decide what the DN-C620 will do at the end of a track.

Play mode setting is "Single Stop"	
Set value	Processing at the end of track
On	<i>(Reserved a next track):</i> Cue at the playback starting position of index 01 of reserved track <i>(Not reserved a next track):</i> Stop
Off (default)	Stop

Play mode setting is "Single Next"	
Set value	Processing at the end of track
On	<i>(Reserved a next track):</i> Cue at the playback starting position of index 01 of reserved track <i>(Not reserved a next track):</i> Cue at the beginning of index 01 of next track
Off (default)	Cue at the beginning of index 01 of next track

Play mode setting is "Single Recue"	
Set value	Processing at the end of track
On	<i>(Reserved a next track):</i> Cue at the beginning of index 01 of reserved track <i>(Not reserved a next track):</i> Cue at the playback starting position
Off (default)	Cue at the playback starting position

Play mode setting is "Continuous"	
Set value	Processing at the end of track
On	<i>(Reserved a next track):</i> Start playback at index 01 of reserved track. If the reserved track is next track of the current track, it will start playback at index 00. <i>(Not reserved a next track):</i> Start playback at index 00. If the current track is final track of the disc, It will stop.
Off (default)	Start playback at index 00. If the current track is final track of the disc, It will stop.

### 3. DEVICE OPERATION

#### 11. Fader start mode (Fader Start)

This feature allows you to decide how the DN-C620 behaves when the Fader Start pins are short-circuited.

Set value	Processing
Play	Unit starts playback when the remote fader pins (9-23) are short circuited and remains playing when the pins open
Play-Pause (default)	Unit starts playback when the remote fader pins (9-23) are short circuited and pauses playback when the pins open

#### 12. Index tally (Index Tally)

This feature allows you to select the processing of INDEX tally pin (17) of the parallel control terminal.

Set value	Processing
Index2 (default)	Output index 2 tally signal to INDEX tally pin (17).
Index3	Output index 3 tally signal to INDEX tally pin (17).

#### 13. Mono mode (Mono)

This feature allows you to force playback of stereo audio into a mono signal sent out both the L and R terminals.

Set value	Processing
Off (default)	Output L and R original signals from the output terminals.
On	Output mixed L and R stereo signals from the output terminals.

#### 14. Auto sleep mode (Auto Sleep)

You can select the behavior that the servo functions will automatically turn off if no operation is performed for set-up time while in stop, pause or cue.

When in the sleep mode, if the ► / II / END MON button is pressed, playback will be started from the beginning of the track in which the sleep mode was set. If the CUE button is pressed, it will standby for the beginning of the track in which the auto sleep was set.

Set value	Processing
Off	Unit never goes into sleep mode
30sec 10min 20min 30min(default)	Unit will goes into sleep mode if no servo functions occur for longer than the user-designated time



15. **Eject lock mode** (Eject Lock)

This feature allows you to prohibit ejecting a disc during playback.

Set value	Processing
On (default)	Unit will not allow anyone to eject a disc while in the Play Mode
Off	Unit will allow a disc to be ejected while in the Play Mode

16. **Procedure for Displaying the Unit's F/W Version** (F/W Version)**[ Using the front panel ]**

1. While in stop and shift mode, press the **MENU/STORE/UTILITY** button.
2. Turn the **jog wheel** until "FW version" appear in the display.



3. Press the **jog wheel**. The Display switches to the firmware version.
4. Press the **STOP/CANCEL** button to cancel.

**[ Using the remote control unit ]**

1. While in stop mode, press the **UTILITY** button.
2. Press the **▲** button or the **▼** button until "F/W version" appear in the display.
3. Press the **ENTER** button. The Display switches to the firmware version.
4. Press the **STOP** button to cancel.

17. **Default** (Default)

Setting this feature allows you to reset all of the unit's preset items to their default values.

## 4. CONTROL FEATURES

### RS-232C CONTROL

Connect a male (D-Sub 9 Pin) to female (D-Sub 9 Pin) straight cable for RS-232C external control by host equipment.

- The RS-232C host can control functions of the DN-C620 externally.
- The DN-C620 automatically transmits status data when status is changed.
- The DN-C620 will respond to status requests by transmitting the associated status data RS-232C specifications.

#### (1) Interface Condition

- Applicable connector : 9-pin D-sub (male)
- Baud rate : 9600 bps
- Data Bit : 8bit
- Parity : None
- Stop bit : 1bit
- Flow control : None
- Pin layout

#### RS-232C

Pin No	Signal Name
1	Ground
6	NC
2	TxD
7	NC
3	RxD
8	NC
4	NC
9	NC
5	S. Ground

#### (2) Control command codes

The control command packets have a data length of 7 bytes or more. ASCII codes from 0x00 to 0x7F are used to receive serial data. At the transmission end, take steps to convert the ASCII codes into HEX data to set the data in the data packets. CR (0x0D) is added as the data packet delimiter.

**Example:** Control command code for number 5 (ASCII code @02005CR)

When transmitting commands consecutively, put more than 100ms blank between commands.

@	0	2	0	0	5	CR
0 × 40	0 × 30	0 × 32	0 × 30	0 × 30	0 × 35	0 × 0d

#### (3) Status Request and Status Information codes

The status data packets have a data length of 7 bytes or more.

ASCII codes from 0x00 to 0x7F are used to transmit serial data. For this reason, the ASCII codes are converted into HEX data before the data is set in the data packets and transmitted. CR (0x0D) is added as the data packet delimiter.

**Example:** Status Information code "Disc In" (ASCII code @0 CDCI CR)

@	0	C	D	C	I	CR
0 × 40	0 × 30	0 × 43	0 × 44	0 × 43	0 × 49	0 × 0d

**(4) Table of Control command codes**

Code	Command	Comment
"@02000"+CR	0	
"@02001"+CR	1	
"@02002"+CR	2	
"@02003"+CR	3	
"@02004"+CR	4	
"@02005"+CR	5	
"@02006"+CR	6	
"@02007"+CR	7	
"@02008"+CR	8	
"@02009"+CR	9	
"@02011"+CR	DISPLAY	
"@02012"+CR	Power Standby	
"@020PW"+CR	Power On	
"@02016"+CR	Volume Up	
"@02017"+CR	Volume Down	
"@02028ON"+CR	RANDOM ON	
"@02028OF"+CR	RANDOM OFF	
"@02029ON"+CR	REPEAT ON	
"@02029OF"+CR	REPEAT OFF	
"@02032"+CR	Track Jump ►►	
"@02033"+CR	Track Jump ◄◄	
"@02034"+CR	INDEX +	
"@02035"+CR	INDEX -	
"@02037ON"+CR	PITCH ON	
"@02037OF"+CR	PITCH OFF	
"@02038"+CR	PTICH +	
"@02039"+CR	PITCH -	
"@02045"+CR	EJECT	
"@02048"+CR	PAUSE	

## 4. CONTROL FEATURES

Code	Command	Comment
"@02050"+CR	F. REVERSE	
"@02052"+CR	F. FORWARD	
"@02053"+CR	PLAY	
"@02054"+CR	STOP	
"@02059"+CR	A-B	
"@020CU"+CR	CUE	
"@020EM"+CR	END MON	
"@020SB"+CR	SKIP BACK	
"@020KL"+CR	Lock Panel's Key	
"@020KU"+CR	Unlock Panel's Key	
"@020DJXXXXXXXXXXXX"+CR	Direct Jump XXXXXXXXXXXX=ttthhmmssff	ttt is Track Number
"@0PMSS"+CR	Play Mode - Single Stop	
"@0PMSN"+CR	Play Mode - Single Next	
"@0PMSR"+CR	Play Mode - Single Recue	
"@0FMCT"+CR	Play Mode - Continuous	
"@0PMRD"+CR	Play Mode - Random	
"@0POPL"+CR	Power On - Play	
"@0POST"+CR	Power On - Stop	
"@0SAPL"+CR	Start Mode Play	
"@0SACU"+CR	Start Mode Cue	
"@0SAST"+CR	Start Mode Stop	
"@0CURC"+CR	Cue Mode Recue	
"@0CUNT"+CR	Cue Mode Next	
"@0AC00"+CR	Auto Cue - OFF	
"@0AC48"+CR	Auto Cue - - 48dB	
"@0AC42"+CR	Auto Cue - - 42dB	
"@0AC36"+CR	Auto Cue - - 36dB	
"@0FIXXX"+CR	Fade In - 000:OFF, 005:0.5sec, 010:1.0sec, ... 100:10.0sec	
"@0FOXXX"+CR	Fade Out - 000:OFF, 005:0.5sec, 010:1.0sec, ... 100:10.0sec	
"@0SBXXX"+CR	SkipBack - 010:1.0sec, 015:1.5sec, ... 300:30.0sec	
"@0EMXX"+CR	End Mon - 05:5sec, 10:10sec, 15:15sec, ... 35:35sec	

Code	Command	Comment
"@0EDXX"+CR	EOM - OF:OFF, 05:5sec, 10:10sec, 15:15sec, 20:20sec, 30:30sec, 60:60sec	
"@0NRXX"+CR	Next Reserve - 00:ON, 01:OFF	
"@0FDPL"+CR	Fader Start -Play	
"@0FDPU"+CR	Fader Start -PlayPause	
"@0ITI2"+CR	Index Tally Index2	
"@0ITI3"+CR	Index Tally Index3	
"@0MOXX"+CR	Mono - 00:ON, 01:OFF	
"@0ASXXXX"+CR	Sleep-0000:OFF,0030:0.5min,1000:10min, 2000:20min, 3000:30min	
"@0ELXX"+CR	Eject Lock - 00:ON, 01:OFF	
"@0DEFL"+CR	General Preset Default	

## 4. CONTROL FEATURES

### (5) Table of Status Request and Status information codes

When a Status Request Command from the host is received by the DN-C620, the DN-C620 sends the Status Information to the host. When the DN-C620 changes status, the DN-C620 automatically sends Status Information to the host.

Mode	Request Code	Status		
Power Mode	"@0?PW"+CR		On	"@0PW00"+CR
			Standby	"@0PW01"+CR
			Off	-
Disc	"@0?CD"+CR		No Disc	"@0CDNC"+CR
			Loading	"@0CDRE"+CR
			Disc In	"@0CDCI"+CR
			Executing	"@0CDEX"+CR
			DiscError(Unformat)	"@0CDCE"+CR
Status	"@0?ST"+CR	Stop	Stop	"@0STST"+CR
			Cue	"@0STCU"+CR
			Sleep	"@0STSL"+CR
		Play	Playback	"@0STPL"+CR
			Playback Pause	"@0STPP"+CR
			FF	"@0STFF"+CR
			RWD	"@0STRW"+CR
			END MON	"@0STEM"+CR
		Other	Ulility / Preset	"@0STED"+CR
			Operation Error	"@0STER"+CR
		Time Mode	"@0?TM"+CR	Time Mode
Track Elapse Time	"@0TMTT"+CR			
Track Remain Time	"@0TMTR"+CR			
File Name	"@0TMFN"+CR			
File Information	"@0TMFI"+CR			
Recorded Date	"@0TMRD"+CR			
Recorded Time	"@0TMRT"+CR			
Recorded Channel	"@0TMCH"+CR			
Track Number	"@0?TR"+CR	Track Number	"@0TRXXX"+CR	

Mode	Request Code	Status	
Display Time	"@0?T1"+CR	Time	"@0T1hhmmssff"+CR
Volume	"@0?VM"+CR	Volume	"@0VMXXX"+CR
Pitch	"@0?PT"+CR	Pitch	"@0PTXXX"+CR
Text Title	"@0?T1"+CR	Text Title	"@0T1XXX..." +CR *1
Text Artist	"@0?T2"+CR	Text Artist	"@0T2XXX..." +CR *1
Text Album	"@0?T3"+CR	Text Album	"@0T3XXX..." +CR *1
POS Code	"@0?C1"+CR	POS Code	"@C1XXXXXXXXXXXXX"+CR
ISRC Code	"@0?C1"+CR	ISRC Code	"@C2XXXXXXXXXXXXX"+CR
Play Mode	"@0?PM"+CR	Single Stop	"@0PMSS"+CR
		Single Next	"@0PMSN"+CR
		Single Recue	"@0PMSR"+CR
		Continuous	"@0FMCT"+CR
		Random	"@PMRD"+CR
Power On	"@0?PO"+CR	Play	"@0POPL"+CR
		Stop	"@0POST"+CR
Start Mode	"@0?SA"+CR	Play	"@0SAPL"+CR
		Cue	"@0SACU"+CR
		Stop	"@0SAST"+CR
Cue Mode	"@0?CU"+CR	Recue	"@0CURC"+CR
		Next	"@0CUNT"+CR
Auto Cue	"@0?AC"+CR	Off	"@0AC00"+CR
		-48dB	"@0AC48"+CR
		-42dB	"@0AC42"+CR
		-36dB	"@0AC36"+CR
Fade In	"@0?FI"+CR	Time	"@0FIXXX"+CR
Fade Out	"@0?FO"+CR	Time	"@0FOXXX"+CR
Skip Back	"@0?SB"+CR	Time	"@0SBXXX"+CR
End Mon	"@0?EM"+CR	Time	"@0EMXX"+CR
End Of Message	"@0?ED"+CR	Time	"@0EDXX"+CR

\*1: 0 to 255 digits

4. CONTROL FEATURES

Mode	Request Code	Status	
Next Tr Reserve	"@0?NR"+CR	On	"@0NR00"+CR
		Off	"@0NR01"+CR
Fader Start	"@0?FD"+CR	Play	"@0FDPL"+CR
		PlayPause	"@0FDPU"+CR
Index Tally	"@0?IT"+CR	Index2	"@0IT12"+CR
		Index3	"@0IT13"+CR
Mono	"@0?MO"+CR	On	"@0MO00"+CR
		Off	"@0MO01"+CR
Sleep	"@0?AS"+CR	Time	"@0ASXXXX"+CR
Eject Lock	"@0?EL"+CR	On	"@0EL00"+CR
		Off	"@0EL01"+CR
Digital FS	"@0?DF"+CR	Fs	"@0DFXX"+CR



## GPIO (Parallel) CONTROL

Use this to control the DN-C620 with dry contact circuit connections.

### (1) Interface Condition

- Applicable connector: 25-pin D-sub (male)
- Connecting signal layout

Pin No.	Signal Name	I/O
1	FG	-
14	PLAY tally	O
2	PLAY command	I
15	PAUSE tally	O
3	PAUSE command	I
16	CUE tally	O
4	CUE command	I
17	INDEX2/INDEX3	O
5	TRACK (+) command	I
18	Reserved	-
6	TRACK (-) command	I
19	Reserved	-
7	SEARCH (Fwd) command	I
20	Reserved	-
8	SEARCH(Rev) command	I
21	Reserved	-
9	FADER START command	I
22	Tally power supply	-
10	Command common	-
23	Command common	-
11	SKIPBACK command	I
24	EOM tally	O
12	Reserved	-
25	Reserved	-
13	Reserved	-

#### NOTE:

- The tally output pin has open collector IC specifications (I<sub>max</sub>. 48mA, V<sub>max</sub>. 5.5V).
- The tally input pin has LVTTTL IC specifications (V<sub>cc</sub> 3.3V).
- Maximum current for Tally power supply (Pin 22) is 100mA.

### (2) Remote control circuit

- Remote control connections

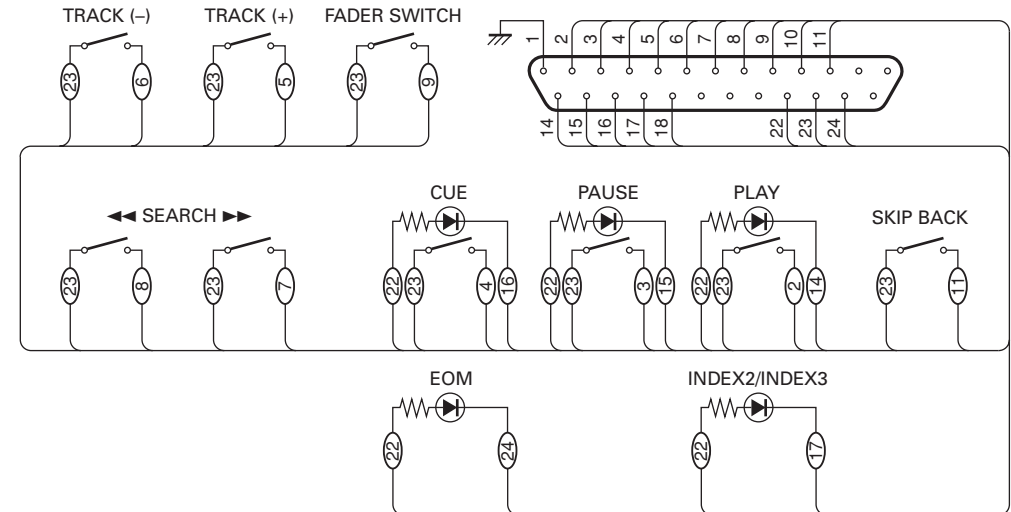

#### NOTE:

- The rating of REMOTE connector pin 22 (TALLY POWER SUPPLY) is +5 VDC, 100 mA maximum. Avoid currents in excess of the rating, or it may cause a malfunction or a risk of fire.

## 4. CONTROL FEATURES

### RC In Control IR FLASH Jack

This is a stereo mini jack for wired remote control.

#### (1) Circuit Diagram

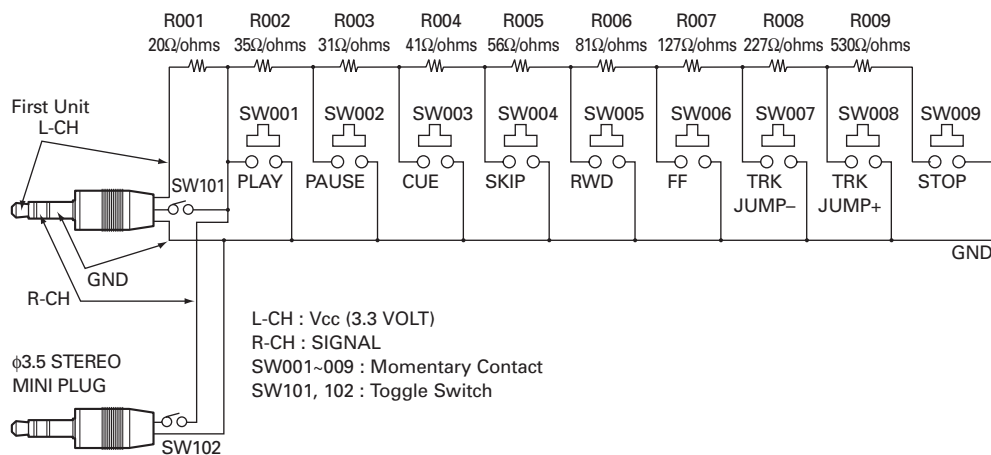

Second and Subsequent Units

- Do not connect the left channel of the plug (Vcc) with R001 (20ohms) in the second and subsequent units.
- Use resistors having a tolerance of with  $\pm 5\%$ .  
Use of resistors having a poorer tolerance will cause incorrect operation.
- Never short circuit the left-channel line (Vcc). Doing so will damage the main unit.

#### (2) Operation with Parallel Connections

A number of DN-C620 units can be simultaneously operated in parallel with one button. Operation with parallel connections can be used with a maximum of 5 units. Connection of 6 or more units will lead to indicator operation.

#### (3) Cable Length

The longer the length of the cable, the more susceptible the system will be to the effects of external noise.

Keep cable lengths to 2 m or less.

Do not locate equipment that produces electrical noise in the vicinity of the cable.

Doing so might lead to incorrect operation due to the noise.

- Do not disconnect or connect the remote control plug during operation of the unit.  
The pins of the plug might cause a short circuit of the pins inside the jack which can stop the operation.
- Pressing more than one button of the wired remote control box at the same time (for combined operations) is not possible.
- Pressing a button of the wired remote control box and a button of the main unit, DN-C620, (for combined operations) is not possible.

#### Note on Connecting the Remote Control Box

- When multiple sets are connected to a single remote control box, the other sets may operate erroneously when this set's power is turned on or off or when the cord is connected or disconnected from the remote control jack.
- Turn off the remote control box's toggle switched (SW101, 102, ...) when turning this set's power on or off or when connecting or disconnecting the cord from the remote control jack while other sets are connected to the remote control box.

## 5. TROUBLESHOOTING

Make sure of the followings before you consider as any malfunctions :

1. Are all the connections correct?
2. Are all system components being operated correctly in accordance with the operating instructions?
3. Are the speakers and amplifier/receiver functioning correctly?

If the Unit still does not function properly, check the symptom against the list below. If the symptom does not correspond to the check list, please contact your dealer.

Problem	Cause	Remedy
Disc is not ejected.	<ul style="list-style-type: none"> <li>• Power operation switch is not turned on.</li> </ul>	<ul style="list-style-type: none"> <li>• Turn the power operation switch on.</li> </ul>
When a disc is loaded, "TOC Error" or "No Disc" is displayed.	<ul style="list-style-type: none"> <li>• Disc is not properly loaded.</li> </ul>	<ul style="list-style-type: none"> <li>• Reload the disc.</li> </ul>
When a disc is loaded, "Disc Error" is displayed.	<ul style="list-style-type: none"> <li>• The disc is not properly recorded.</li> </ul>	<ul style="list-style-type: none"> <li>• Turn the power off and on again to eject the disc.</li> </ul>
When the PLAY button is pressed, playback does not start.	<ul style="list-style-type: none"> <li>• Disc is dirty or scratched.</li> </ul>	<ul style="list-style-type: none"> <li>• Clean the disc.</li> </ul>
There is no sound, or it is distorted.	<ul style="list-style-type: none"> <li>• Output cord is not properly connected.</li> <li>• Amplifier adjustment is inappropriate.</li> </ul>	<ul style="list-style-type: none"> <li>• Connect the output cord properly.</li> <li>• Readjust the amplifier.</li> </ul>
A specific section of the disc will not play.	<ul style="list-style-type: none"> <li>• Disc is dirty or scratched.</li> </ul>	<ul style="list-style-type: none"> <li>• Clean the disc.</li> </ul>
Program play does not work.	<ul style="list-style-type: none"> <li>• Program play operation has been performed improperly.</li> </ul>	<ul style="list-style-type: none"> <li>• Restart Program play.</li> </ul>
Remote control is not working.	<ul style="list-style-type: none"> <li>• No batteries or flat batteries.</li> </ul>	<ul style="list-style-type: none"> <li>• Ensure that batteries are correctly inserted.</li> <li>• Replace the batteries with a fresh set.</li> </ul>
File does not play.	<ul style="list-style-type: none"> <li>• Decoding Error.</li> </ul>	<ul style="list-style-type: none"> <li>• Check that the file you are trying to play has a supported file extension and is a format that the DN-C620 supports.</li> </ul>

## 6. SPECIFICATIONS

### ■ GENERAL

**Disc type :** Standard compact discs (12 cm and 8 cm)  
CD-R, CD-RW

### ■ AUDIO SECTION

**Audio channel :** 2 channel stereo  
**Frequency response :** 10 to 20,000Hz  $\pm$  1.0 dB  
**Dynamic range :** 98 dB  
**Signal-to-noise Ratio :** 100 dB (1kHz, 0 dB playback, A filter)  
**Channel separation :** 96 dB (1kHz, 0 dB playback, A filter)  
**Total Harmonic Distortion :** 0.004 % (1kHz, 0 dB playback, A filter)  
**Analog output :**  
     **Unbalanced output (RCA) :** 2.0 Vrms at 0 dB disc, 10 kohms  
     **Variable range(VARIABLE) :** 4.0 Vrms at 0dB disc, volume max.  
     **Balanced output (XLR) :** +18 dBu at 0 dB disc, 600 ohms  
     **Variable range :** +24 dBu to +0 dBu at 0 dB disc  
**Digital output :**  
     **Unbalanced output (RCA) :** 0.5 Vp-p, 75 ohms  
     **Balanced output (XLR) :** 3.5 Vp-p, 110 ohms  
     **Signal Format :** SPDIF or IEC-958 Type II  
**Headphone Output :** 20 mW, 33 ohms  
**Variable Pitch Control :**  $\pm$ 12 % max.  
**Frame Search Accuracy :** 1/75 second

### ■ SIGNAL SYSTEM

**Sampling Frequency:** 44.1 kHz at Normal Pitch  
**Quantization :** 16-bit Linear

### ■ REMOTE CONTROL

**Serial remote :** RS232C, D-Sub 9-pin  
**Parallel remote :** D-Sub 25-pin  
**IR control input :** IR sensor  
**IR FLASH :** RC In Control Jack (1/8" stereo mini Jack)

### ■ POWER SUPPLY

**U.S.A. & Canada models :** 120 V AC  $\pm$ 10 %, 60 Hz  
**European, U.K. and Asia/Pacific models :** 230 V AC  $\pm$ 10 %, 50 Hz  
**Power Consumption :** 14 W (U.S.A. & Canada models)  
 14 W (European, U.K. and Asia/Pacific models)

### ■ CABINET, etc.

**Installation :** 19-inch 1U rack space  
**Maximum Dimensions :** 482.6 (W)  $\times$  44 (H)  $\times$  325 (D)mm  
 19" (W)  $\times$  1.7" (H)  $\times$  12.8" (D)  
**Weight :** 4.3 kg, 9.5 lbs

### ■ ENVIRONMENTAL CONDITIONS

**Operating temperature :** +5°C to +35°C  
**Operating humidity :** 25% to 85%, non condensing  
**Storage temperature :** -20°C to +60°C  
**Storage humidity :** 25% to 85%, non condensing

### ■ DIMENSIONS

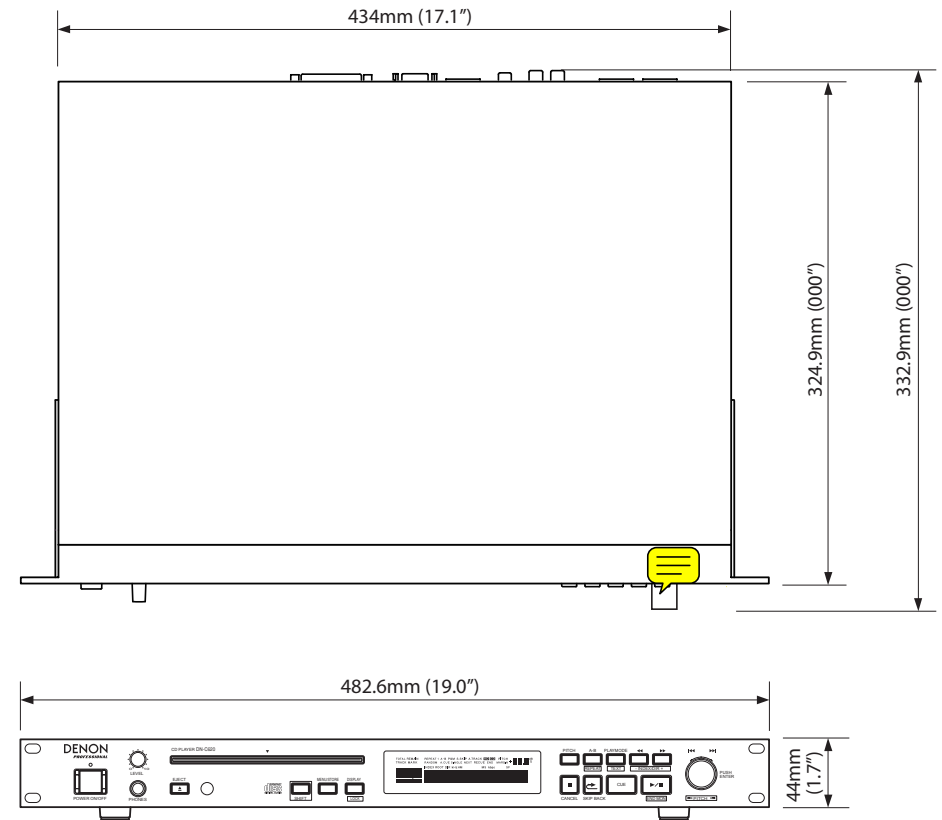

\* For improvement purposes, specifications and design are subject to change without notice.



D&M Holdings Inc.  
PROFESSIONAL BUSINESS COMPANY

