

Portable

iNSPIRE iP300

600 Watt Powered Column Loudspeaker with 2 x 6.5" Woofers, 4 Neodymium Drivers, KLARK TEKNIK Spatial Sound Technology, Reverb, Digital Mixer, Remote Control via iPhone/iPad and Bluetooth Audio Streaming

- Column loudspeaker for portable PA applications and high quality music playback
- KLARK TEKNIK's revolutionary SST (Spatial Sound Technology) for creating 3D acoustic environments
- Extremely wide sound dispersion provides consistent sound to the audience and performers
- 600 Watt power, multi-channel KLARK TEKNIK Class-D technology
- 3 channel digital mixer with gain setting recall
- High-quality KLARK TEKNIK digital reverb for amazing vocal enhancement
- Comprehensive remote control via Apple iPhone/iPad*
- High quality Bluetooth* stereo audio streaming
- DSP presets for application type and speaker positioning
- Intuitive single rotary control user interface with LCD display for ease of navigation
- Dual 6.5" high excursion low frequency driver for low distortion sub-bass response
- 4 x 2" neodymium drivers with edge wound aluminium voice coils for extended high frequency reproduction
- Multiple height configurations for floor or elevated use
- High impact and lightweight enclosure



Although we refer to it as a “column” loudspeaker, the iNSPIRE iP300 delivers the powerful, high-quality sound and optimised dispersion inspired by our award-winning line array products – in a surprisingly lightweight and easy to use, all-in-one form factor. Thanks to an on-board 3-channel digital mixer and multichannel 600-Watt Class-D amplifier driving 2 x 6.5" high excursion low frequency drivers and 4 x 2" neodymium drivers, the iP300 is ideally-suited for small to medium-sized performance venues, houses of worship, boardroom presentations, nightclubs, and much more.



Weighing in at a very modest 11.9 kg (26.2 lbs), the iP300 is easy to transport and features industry-leading KLARK TEKNIK Spatial Sound Technology, Reverb, and Class-D multichannel amplifier – plus convenient Bluetooth stereo audio streaming and iPhone/iPad remote control.

Portable

iNSPIRE iP300

600 Watt Powered Column Loudspeaker with 2 x 6.5" Woofers, 4 Neodymium Drivers, KLARK TEKNIK Spatial Sound Technology, Reverb, Digital Mixer, Remote Control via iPhone/iPad and Bluetooth Audio Streaming

- Integrated protective perforated steel mesh grilles
- Integral ergonomic carrying handle for ease of portability
- 3-Year Warranty Program*
- Designed and engineered in the U.K.

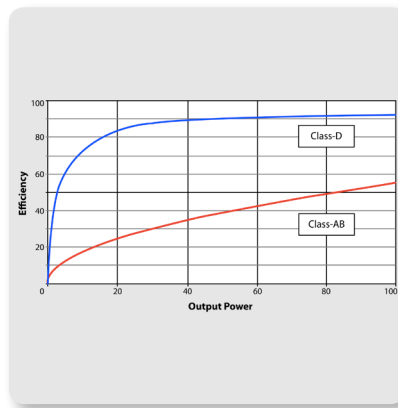

Tiny PA – 600 Watts of Perfect Sound

Compact and designed for maximum portability, iP300 setup is fast and easy; just attach the column section(s) to the base and connect your mic or mixer feed and power. Our revolutionary Class-D amplifier technology provides 600 Watts of incredible sonic performance in an easy-to-use, ultra-portable and lightweight package. This amazing technology makes it possible to design and build extremely powerful products that are significantly lighter in weight than their traditional counterparts, while using less energy and protecting the environment.

The lightweight Switch Mode Power Supply, coupled with an industry-leading DSP module, provides dynamic equalisation and sophisticated limiting functions to ensure optimal performance and long-term reliability. The powerful iP300 fills the room with the world-famous **TURBOSOUND** "sound" that has won the coveted Queen's Award – an unprecedented three times.

*The Bluetooth word mark and logos are registered trademarks owned by Bluetooth SIG, Inc. and any use of such marks is under license. All third-party trademarks are the property of their respective owners. Their use neither constitutes a claim of the trademark nor affiliation of the trademark owners with MUSIC Group. Product names are mentioned solely as a reference for compatibility, effects and/or components. Warranty details can be found at music-group.com.

Portable

iNSPIRE iP300

600 Watt Powered Column Loudspeaker
with 2 x 6.5" Woofers, 4 Neodymium Drivers,
KLARK TEKNIK Spatial Sound Technology,
Reverb, Digital Mixer, Remote Control via
iPhone/iPad and Bluetooth Audio Streaming

Outstanding Sound Dispersion

Much like the huge line array systems you've experienced at concerts and outdoor festivals (we make those too), the 2" neodymium midrange / extended high-frequency drivers in the iP300 columns are strategically placed to provide an extremely wide dispersion pattern. Such wide coverage eliminates the need for monitor wedges for the performers and creates a more even, sonically balanced soundscape that covers the entire room. By taking advantage of the arrival-time differential between sound waves reaching the left and right ears, iP300's groundbreaking Spatial Sound Technology (SST) creates a wide, well-defined virtual 3-D acoustic environment, enveloping the listener in a richer and more realistic experience. No matter where you sit, the location of the onstage voices and instruments are perceived in their rightful position within the soundscape, for a performance that is beautifully open and transparent – with unparalleled intelligibility,unprecedented three times.



KLARK TEKNIK – Inspired Technology

KLARK TEKNIK is recognised worldwide as one of the most prestigious British audio companies, with a 40-year pedigree and even a TEC Lifetime Achievement Award to back it up. The Company has designed and manufactured products for world-class artists, and their legendary DN780 reverb processor is considered by leading audio engineers around the world as the industry standard. Check out their website to learn more about KLARK TEKNIK's legendary heritage.

TURBOSOUND is proud to incorporate custom-engineered KLARK TEKNIK Class-D amplifier and DSP technologies into their products.

DSP – the Secret to Superb Sound

From the instant your signal enters the iP300, the built-in DSP takes over ensuring the highest possible signal integrity. Much more than just selective EQ enhancement, the 24-bit processor analyses the incoming signal and intelligently applies specific filters to actually improve the sound quality. It's like having an audio engineer monitoring the input and output signals, dialing in the perfect EQ and constantly making subtle adjustments to the crossover, compressor/limiter, three discrete amplifier channels and more – all of which adds up to significantly better sound.



Portable

iNSPIRE iP300

600 Watt Powered Column Loudspeaker
with 2 x 6.5" Woofers, 4 Neodymium Drivers,
KLARK TEKNIK Spatial Sound Technology,
Reverb, Digital Mixer, Remote Control via
iPhone/iPad and Bluetooth Audio Streaming



Custom-Engineered Drivers

Our speakers are designed specifically for each application – it's what sets us apart from the competition. When you buy a **TURBOSOUND** speaker system, you can rest assured that the speakers inside have been engineered to perform flawlessly in conjunction with every other element for truly professional results.

Built-in Digital Mixer – Comprehensive Remote Control

The iP300 features a fully addressable onboard digital mixer with two combo jack/XLR connectors that accept balanced and unbalanced connections for dynamic mics and line-level instruments. The simple and intuitive user interface consists of a single rotary push-encoder with Process, Setup, Exit and Enter function buttons. A beautifully-backlit display controls DSP functions including mixer parameters, 3 band EQ, and presets. All settings can be controlled locally, or via free downloadable iPhone/iPad apps – and locked down to prevent unauthorised access.

We take Bluetooth a step further, giving you total control of the iP300 directly from your iPhone or iPad. This amazing feature lets you adjust all settings from either the listening area or the stage, for the perfect sound every time. The dedicated apps are available free of charge at turbosound.com, or from the Apple App Store.

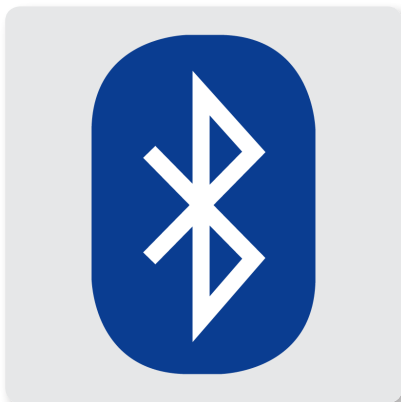
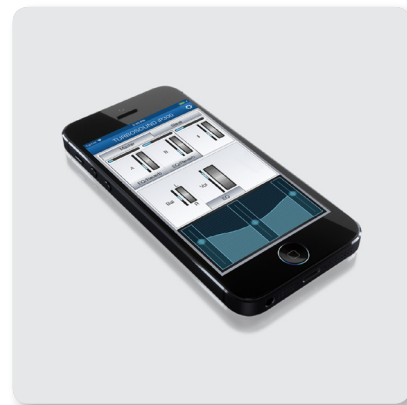

Bluetooth Ready

The days of tape decks, CD and even mp3 players are long gone. Now your music lives on your smartphone or computer tablet, so you can stop searching for those outdated cables and fancy adapters. An industry first, the iP300 puts all your music at your fingertips via stereo Bluetooth. Now with a simple wave of your hand, you can stream music from any Bluetooth-equipped iOS device, such as your iPad, iPod touch, iPhone – or even your laptop computer.

Portable

iNSPIRE iP300

600 Watt Powered Column Loudspeaker
with 2 x 6.5" Woofers, 4 Neodymium Drivers,
KLARK TEKNIK Spatial Sound Technology,
Reverb, Digital Mixer, Remote Control via
iPhone/iPad and Bluetooth Audio Streaming

Stunning Performance – Superb Value

The INSPIRE iP300 active PA loudspeaker stands head and shoulders above the rest of the pack and delivers exceptional performance, even when pushed to the limit. Ultra-lightweight and powerful with custom-designed transducers, an integrated mixer, stereo Bluetooth streaming, iPhone/iPad remote control, 600 Watts of Class-D output power and Digital Sound Processing, the iP300 is ideal for both portable and installed applications – at a price unheard of in this class.

Experience the iP300 at your local dealer today, or get yours online today – and let **TURBOSOUND** take your performance to the next level!



You Are Covered

We always strive to provide the best possible Customer Experience. Our products are made in our own MUSIC Tribe factory using state-of-the-art automation, enhanced production workflows and quality assurance labs with the most sophisticated test equipment available in the world. As a result, we have one of the lowest product failure rates in the industry, and we confidently back it up with a generous **Warranty** program.

Portable

iNSPIRE iP300

600 Watt Powered Column Loudspeaker
with 2 x 6.5" Woofers, 4 Neodymium Drivers,
KLARK TEKNIK Spatial Sound Technology,
Reverb, Digital Mixer, Remote Control via
iPhone/iPad and Bluetooth Audio Streaming

Frequency Response Sensitivity 1 W / 1 m

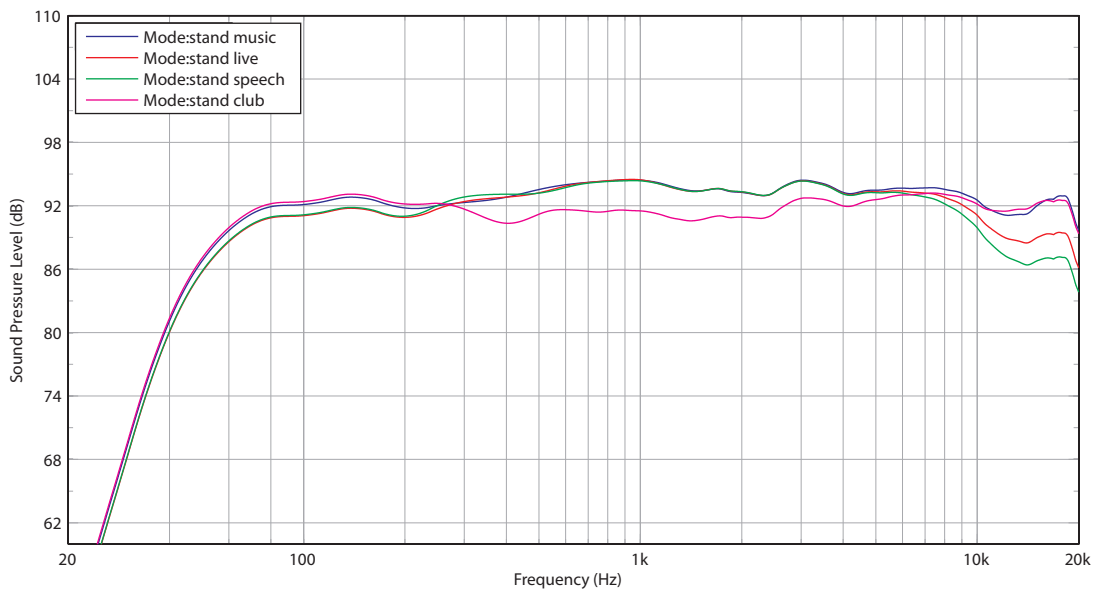
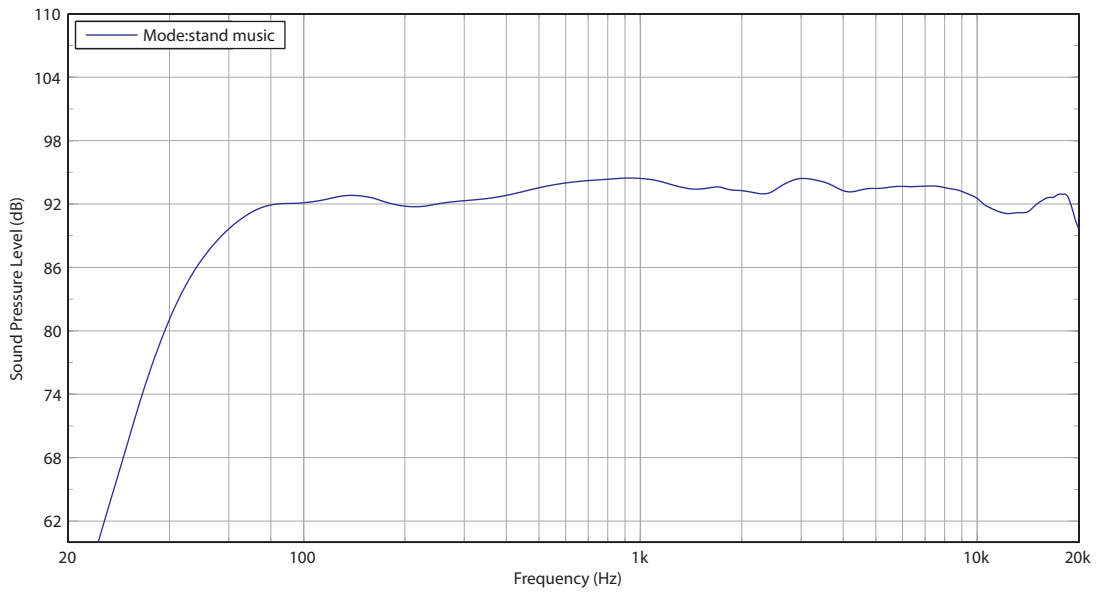

Portable

iNSPIRE iP300

600 Watt Powered Column Loudspeaker
with 2 x 6.5" Woofers, 4 Neodymium Drivers,
KLARK TEKNIK Spatial Sound Technology,
Reverb, Digital Mixer, Remote Control via
iPhone/iPad and Bluetooth Audio Streaming

Horizontal Beamwidth

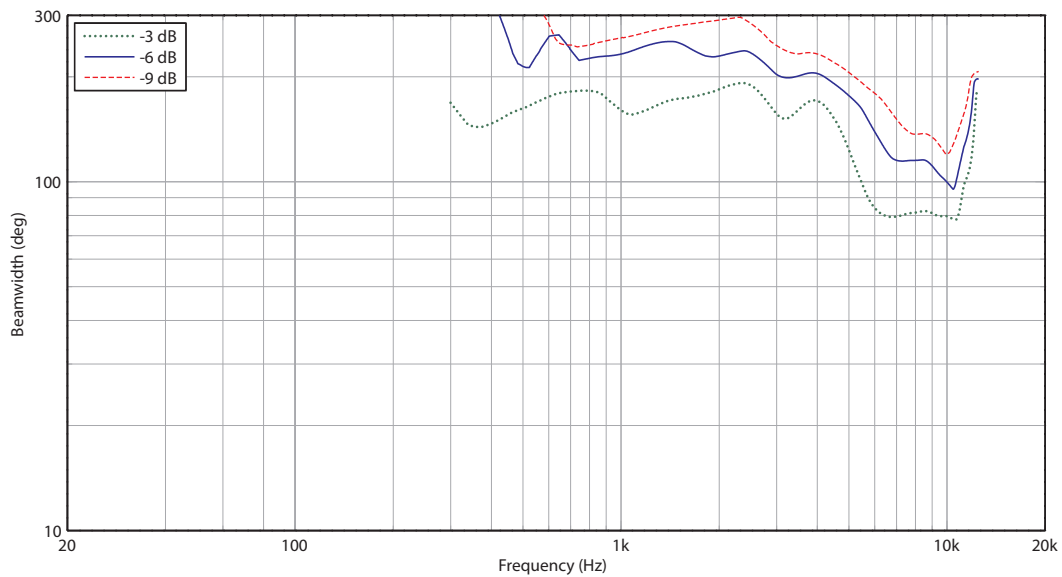

Vertical Beamwidth

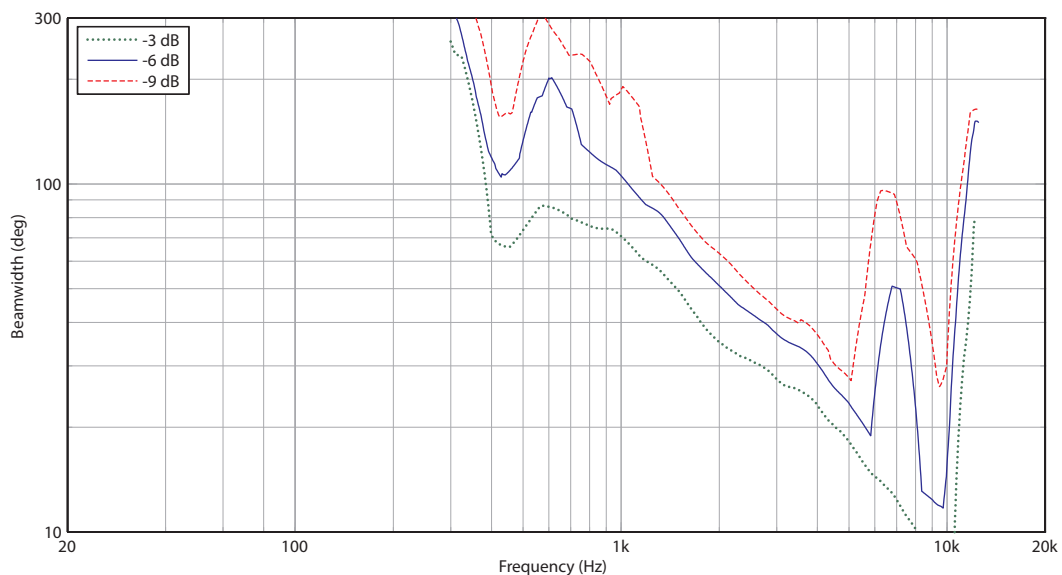

Portable

iNSPIRE

iP300

600 Watt Powered Column Loudspeaker
with 2 x 6.5" Woofers, 4 Neodymium Drivers,
KLARK TEKNIK Spatial Sound Technology,
Reverb, Digital Mixer, Remote Control via
iPhone/iPad and Bluetooth Audio Streaming

Horizontal Polar Plots

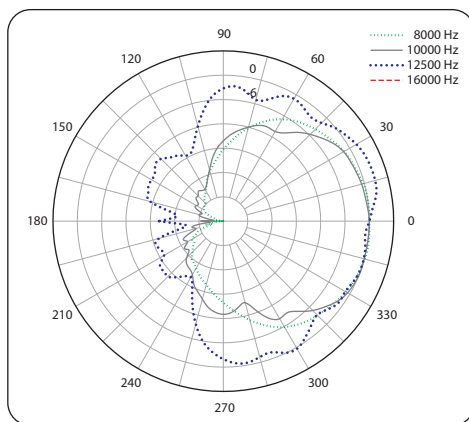
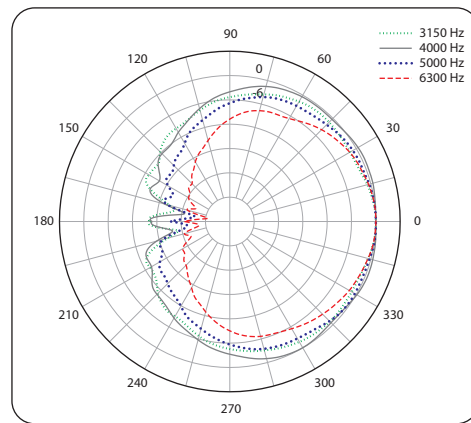
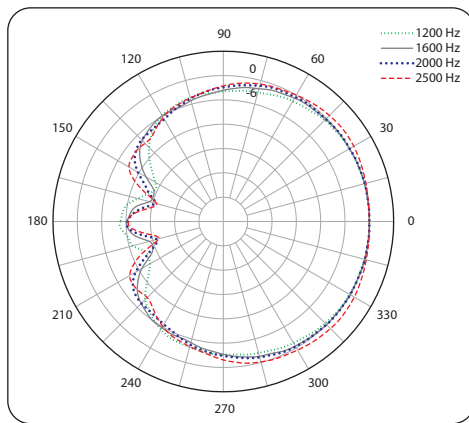
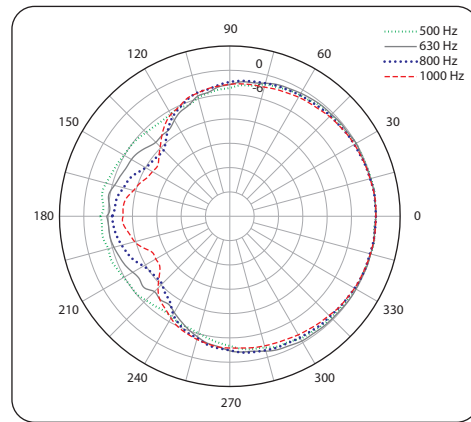
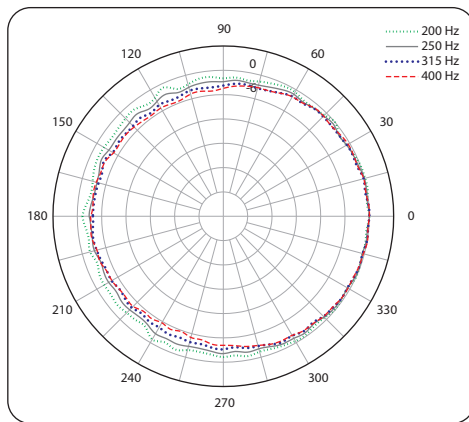

Portable

iNSPIRE

iP300

600 Watt Powered Column Loudspeaker
with 2 x 6.5" Woofers, 4 Neodymium Drivers,
KLARK TEKNIK Spatial Sound Technology,
Reverb, Digital Mixer, Remote Control via
iPhone/iPad and Bluetooth Audio Streaming

Vertical Polar Plots

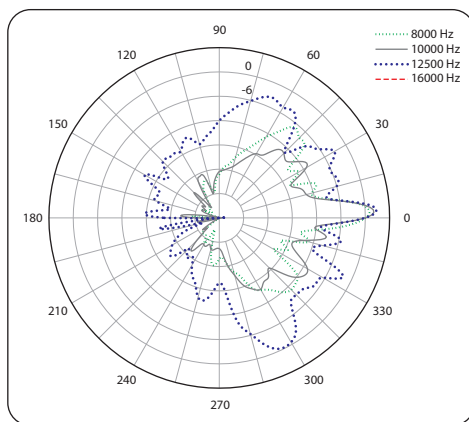
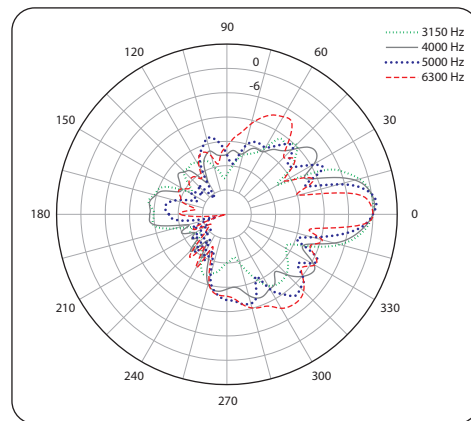
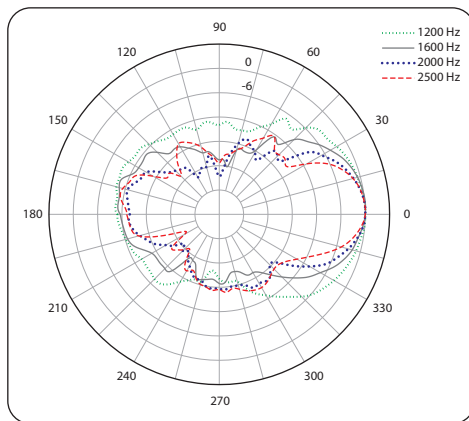
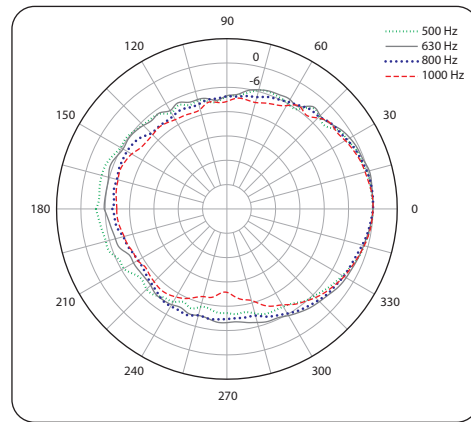
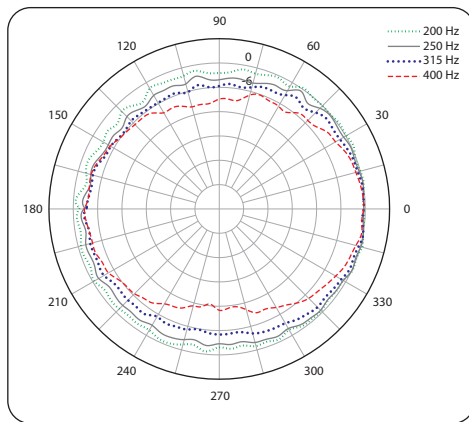

Portable

iNSPIRE iP300

600 Watt Powered Column Loudspeaker
with 2 x 6.5" Woofers, 4 Neodymium Drivers,
KLARK TEKNIK Spatial Sound Technology,
Reverb, Digital Mixer, Remote Control via
iPhone/iPad and Bluetooth Audio Streaming

Dimensions

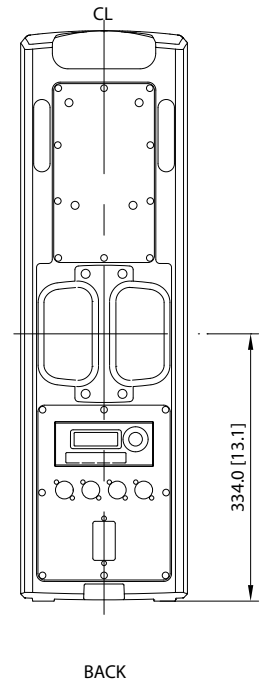
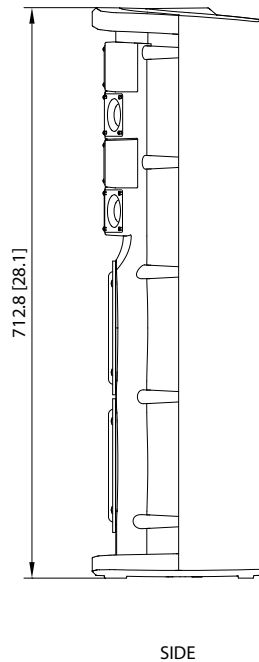
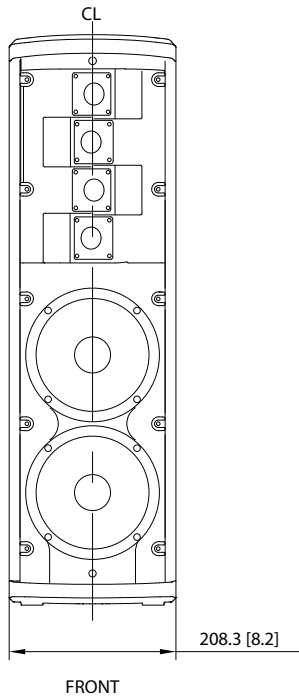
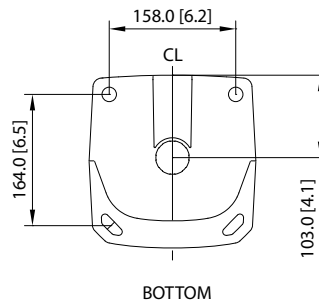
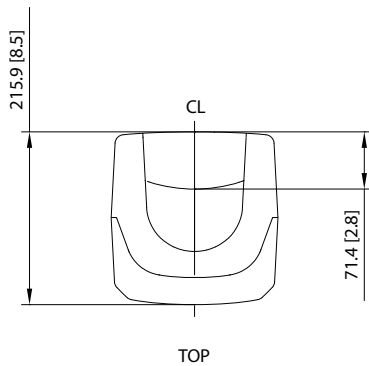

Portable

iNSPIRE

iP300

600 Watt Powered Column Loudspeaker
with 2 x 6.5" Woofers, 4 Neodymium Drivers,
KLARK TEKNIK Spatial Sound Technology,
Reverb, Digital Mixer, Remote Control via
iPhone/iPad and Bluetooth Audio Streaming

Technical Specifications

System

Frequency response	50 Hz – 20 kHz \pm 3 dB 40 Hz – 20 kHz -10 dB
Nominal Dispersion	120° H @ -6 dB points
Maximum SPL	122 dB
Crossover type	2 way, active
Transducers	2 x 6.5" (167 mm) LF driver 4 x 2" (54.2 mm) HF driver
Limiter	Independent high, mid and low frequency

Amplifier

Maximum output power*	600 W
Type	LF: Class-D HF: Class AB
Protection	Short circuit, open circuit, thermal
Amplifier channels	2

Connectors

Input A / B	2 x combo jack / XLR
Sensitivity	4 dBu, nominal
Input impedance	16 k Ω unbalanced, 32 k Ω balanced
Maximum input level	+22 dBu
Link output	XLR
Mains supply	IEC mains connector with integrated power switch†

Controls

Hardware	Rotary push-encoder
Software	iOS/Android interface via Bluetooth

DSP

Factory EQ presets	Positioning, sound mode
Display	LCD 128 x 32, blue, backlit
Level	Main
Equalisation	Bass, middle and treble
Protection	Lock-out function for all settings

Input Mixer

Equalisation	Bass and treble
Reverb	KLARK TEKNIK design

Portable

iNSPIRE

iP300

600 Watt Powered Column Loudspeaker
with 2 x 6.5" Woofers, 4 Neodymium Drivers,
KLARK TEKNIK Spatial Sound Technology,
Reverb, Digital Mixer, Remote Control via
iPhone/iPad and Bluetooth Audio Streaming

Technical Specifications

Bluetooth Wireless Technology

Frequency range	2402 MHz ~ 2480 MHz
Channel number	79
Version	Bluetooth 4.1 dual mode
Output	8 dBm
Compatibility	Supports GATT/A2DP 1.2 profile
Maximum communication range	30 m typical
Connectivity	Master-slave: stereo pairing link

Power Supply

Power consumption	80 W @ 1/8 max power
Voltage (fuses)	
USA / Canada / Japan	100-120 V~, 50/60 Hz (T 6.3 A H 250 V)
UK / Australia / Europe	220-240 V~, 50/60 Hz (T 3.15 A H 250 V)
Korea / China	220-240 V~, 50/60 Hz (T 3.15 A H 250 V)

Enclosure

Dimensions (H x W x D)	713 x 208 x 216 mm (28.1 x 8.2 x 8.5")
Net weight	11.9 kg (26.2 lbs)
Construction	Engineering plastic (GXPP)
Finish	Semi matt black paint
Grille	Powder coated perforated steel

Portable

iNSPIRE

iP300

600 Watt Powered Column Loudspeaker
with 2 x 6.5" Woofers, 4 Neodymium Drivers,
KLARK TEKNIK Spatial Sound Technology,
Reverb, Digital Mixer, Remote Control via
iPhone/iPad and Bluetooth Audio Streaming



Portable

iNSPIRE

iP300

600 Watt Powered Column Loudspeaker
with 2 x 6.5" Woofers, 4 Neodymium Drivers,
KLARK TEKNIK Spatial Sound Technology,
Reverb, Digital Mixer, Remote Control via
iPhone/iPad and Bluetooth Audio Streaming



Portable

iNSPIRE

iP300

600 Watt Powered Column Loudspeaker
with 2 x 6.5" Woofers, 4 Neodymium Drivers,
KLARK TEKNIK Spatial Sound Technology,
Reverb, Digital Mixer, Remote Control via
iPhone/iPad and Bluetooth Audio Streaming

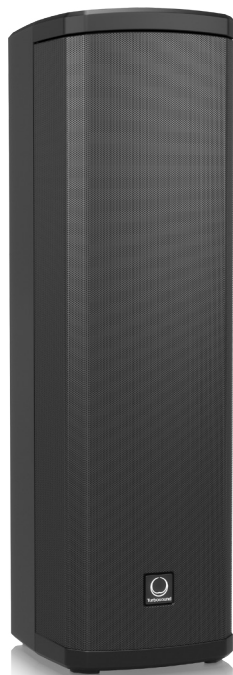

Portable

iNSPIRE iP300

600 Watt Powered Column Loudspeaker
with 2 x 6.5" Woofers, 4 Neodymium Drivers,
KLARK TEKNIK Spatial Sound Technology,
Reverb, Digital Mixer, Remote Control via
iPhone/iPad and Bluetooth Audio Streaming



Portable

iNSPIRE iP300

600 Watt Powered Column Loudspeaker
with 2 x 6.5" Woofers, 4 Neodymium Drivers,
KLARK TEKNIK Spatial Sound Technology,
Reverb, Digital Mixer, Remote Control via
iPhone/iPad and Bluetooth Audio Streaming

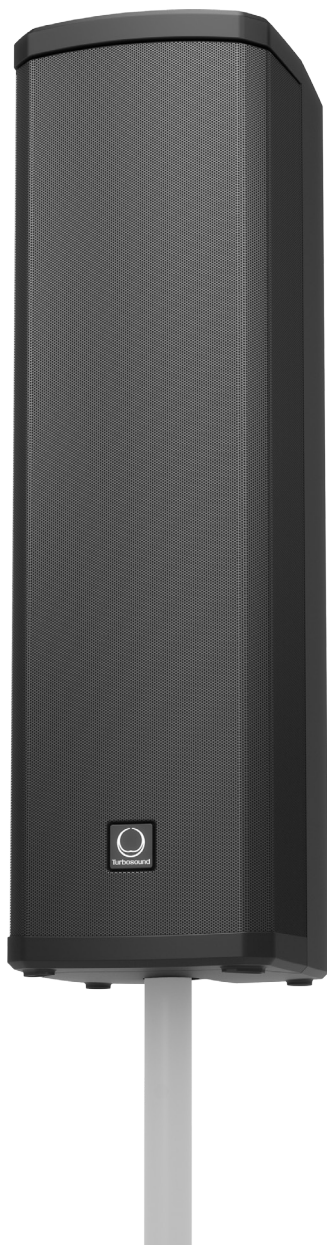

Portable

iNSPIRE iP300

600 Watt Powered Column Loudspeaker
with 2 x 6.5" Woofers, 4 Neodymium Drivers,
KLARK TEKNIK Spatial Sound Technology,
Reverb, Digital Mixer, Remote Control via
iPhone/iPad and Bluetooth Audio Streaming



Portable

iNSPIRE iP300

600 Watt Powered Column Loudspeaker
with 2 x 6.5" Woofers, 4 Neodymium Drivers,
KLARK TEKNIK Spatial Sound Technology,
Reverb, Digital Mixer, Remote Control via
iPhone/iPad and Bluetooth Audio Streaming

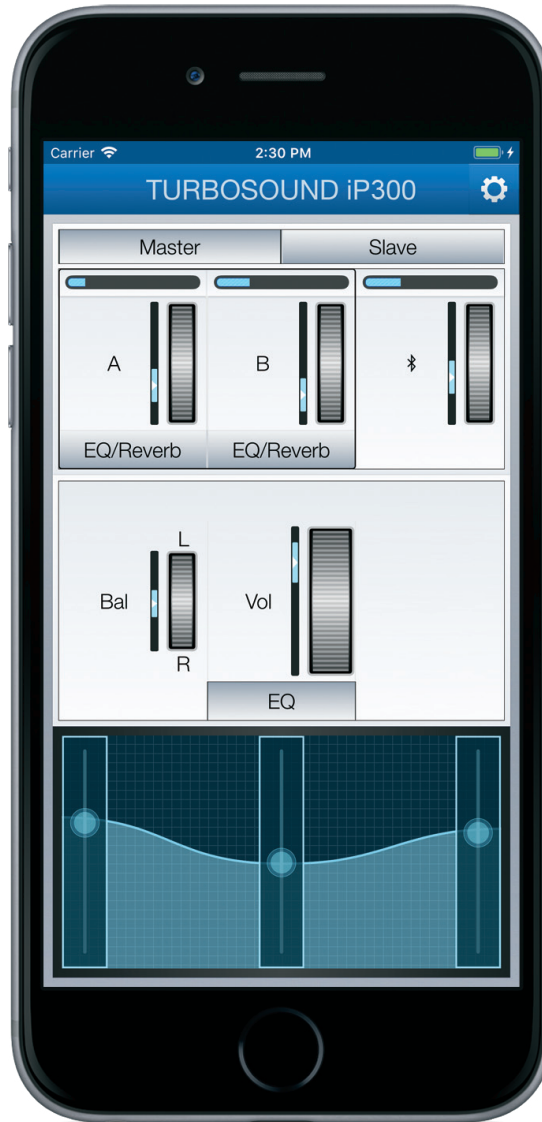

For service, support or more information contact the TURBOSOUND location nearest you:

Europe
MUSIC Tribe Brands UK Ltd.
Tel: +44156 273 2290
Email: CARECrea@music-group.com
CAREEnte@music-group.com
CARELife@music-group.com

USA/Canada
MUSIC Tribe Commercial NV Inc.
Tel: +1 702.800 8290
Email: CARECrea@music-group.com
CAREEnte@music-group.com
CARELife@music-group.com

Japan
MUSIC Tribe Services JP K.K.
Tel: +81 3 6231 0453
Email: CARECrea@music-group.com
CAREEnte@music-group.com
CARELife@music-group.com

MUSIC Tribe accepts no liability for any loss which may be suffered by any person who relies either wholly or in part upon any description, photograph, or statement contained herein. Technical specifications, appearances and other information are subject to change without notice. All trademarks are the property of their respective owners. MIDAS, KLARK TEKNIK, LAB GRUPPEN, LAKE, TANNØY, TURBOSOUND, TC ELECTRONIC, TC HELICON, BEHRINGER, BUGERA and COOLAUDIO are trademarks or registered trademarks of MUSIC Group IP Ltd.
© MUSIC Group IP Ltd. 2018 All rights reserved.