

X1-212/90

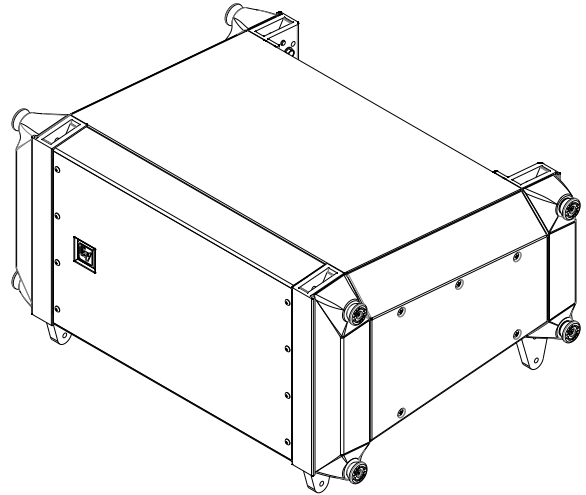

- **MBH** – Mid-Band Hydra Line Source Technology
- **WCH** – Wavefront-shaping Circular Hydra
- **IRS** – Integrated Rigging System
- Proprietary EV FIR-Drive



The X1-212/90 from Electro-Voice is a two-way vertical line array loudspeaker can be used in a wide variety of applications where wide bandwidth, vertical and horizontal directivity control, and high efficiency are required in a compact cost-effective package. For high frequencies, the X1-212/90 utilizes two (2) ND2R high-output 2-inch titanium compression drivers directly coupled to a pair of WCH Plane Wave Generators on a 90° waveguide optimized for uniform pattern control and smooth, linear response. For low frequencies, the SMX2121 12-inch woofer was developed using FEA optimization for motor, suspension, and electrical design to provide low distortion, high efficiency, and maximum intelligibility at high SPL. The woofer is coupled to an MBH effectively emulates the acoustic behavior of a double line of four (4) 3-inch point sources to deliver superior mid-band coupling while maintaining the efficiency, power, and bandwidth of a 12-inch transducer. The passive crossover employs a steep, eighth order topology resulting in acoustic crossover slopes through the critical crossover region in excess of 80-dB per octave for linear summation and smooth off-axis response with passive equalization for improved definition over the critical vocal range regardless of array size.

The X1-212/90 is an ideal cost effective solution for many live sound reinforcement and fixed-install applications. The vertical trapezoidal enclosure is constructed of weather-resistant birch and coated with EVCoat for enhanced durability. The enclosure features the IRS, a captive twist-lock multi-angle

arraying system designed by Electro-Voice to significantly reduce load-in/load-out time of any size array. IRS has been engineered with the flexibility to deploy a system using the two (2) most common methods of array set-up:

- Compression method by using a pull-up kit (Sold separately).
- Fixed angles locked by using secondary rigging pins (Included).

X1-212/90 with IRS rigging is rated for use for up to 24 elements for normal arrays. **LAPS 3** or higher (Line Array Prediction Software) accurately provides fast array configuration for coverage results, rigging details, and allowed rigging configurations. It also provides information for the creation of steered/shaped subwoofer arrays.

The input panel provides dual Neutrik NL8 connectors for fast connectivity between loudspeakers. Passive/Bi-amp operation is selected via an internal connector.

The advanced acoustic and mechanical designs of X1 series loudspeakers, combined with LAPS 3, provide the tools and flexibility to easily design and deploy vertical line array systems.

Technical specifications

Frequency Response (-3 dB):	57 Hz - 16 kHz ¹
Horizontal Coverage:	90°
Vertical Coverage:	Array dependent
Rec. High-Pass Frequency:	50 Hz
Max Calculated SPL:	143 db Peak ²
Configuration:	Passive, Bi-amp
Passive Crossover Freq.:	1600 Hz
Passive Axial Sensitivity:	98 dB (1 W/1 m) ⁴
Passive Power Handling:	500 W continuous, 2000 peak
Passive Impedance:	8 Ω (nominal, 6.4Ω (min)
LF Transducer:	SMX2121, 12-in (305 mm) driver
LF Axial Sensitivity:	98 dB (1 W/1 m) ⁴
LF Power Handling:	400 W continuous, 1600 W peak
LF Impedance:	8 Ω (nominal), 6.1 Ω (min)
HF Transducer:	2 x ND2R, 2-in (51 mm) diaphragm compression driver
HF Axial Sensitivity:	110 dB (1 W/1 m) ⁴
HF Power Handling:	120 W continuous, 480 W peak ³
HF Impedance:	8 Ω (nominal, 6.0 Ω (min)
Connectors:	Dual NL8 type connector
Enclosure:	13-ply weather resistant birch with EVCoat
Grille:	16 GA powder coated galvaneal
Suspension:	IRS — Integrated Rigging System
Dimensions (H x W x D):	13.5 in x 28.77 in x 12.04 in (342.9 mm x 730.8 mm x 534.4 mm)
Net Weight:	92 lb (41.7 kg)
Shipping Weight:	106 lb (48 kg)

1. Full-space anechoic array performance with FIR-Drive preset.
2. Full-space measurement of HF section of 4 elements. SPL adjusted for 1m distance.
3. AES 2-1984 power test.
4. Full-space anechoic measurement of a single element.

System overview

Impedance Passive:

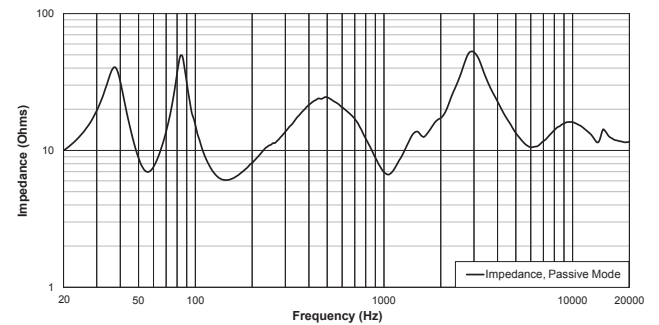

Impedance Biamp:

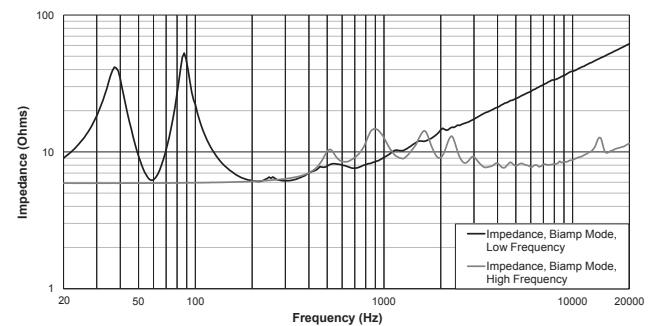

Beamwidth (Active):

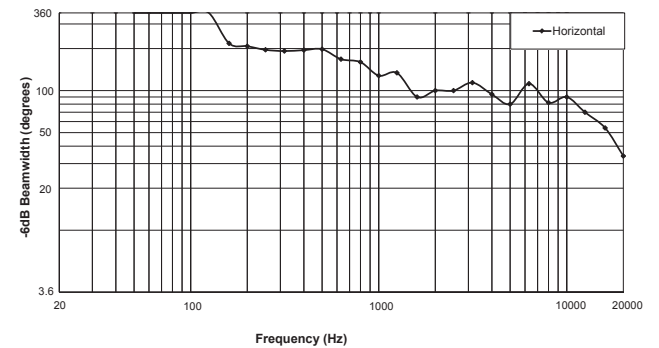

Notice!

Using X1-212/90 v.0.2 DSP FIR-Drive settings for the Beamwidth.

Dimensions:

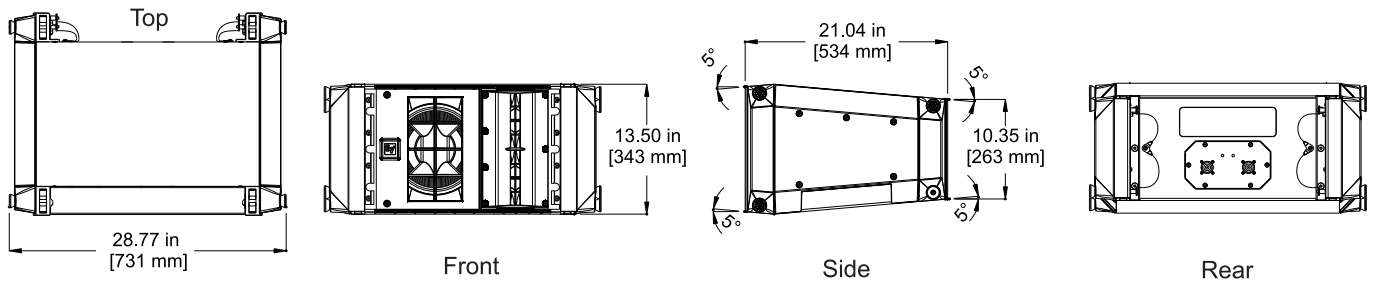

Notice!

Acoustic measurement reference axis is the center of the grille.

X1 and X2 line array elements they are designed to use only one (1) model type in a vertical array.

Block Diagram Passive:

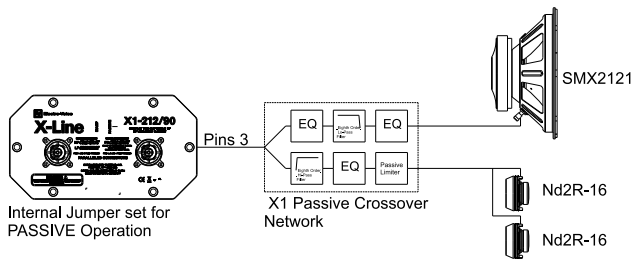

Block Diagram Biamp:

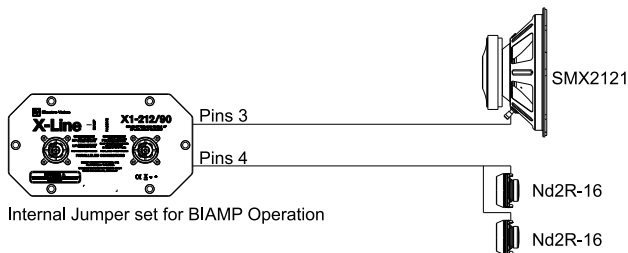

Caution!

This Electro-Voice loudspeaker should be suspended overhead only in accordance with the procedures and limitations specified. This system should be suspended with certified rigging hardware by an authorized rigging professional and in complete compliance with local, state, and federal overhead suspension ordinances.



Notice!

Do not mix X1 and X2 full-range loudspeaker model types in the same vertical array. Although enclosure and rigging is identical for

Compatible System Solutions:

DX46	DX46 Loudspeaker Controller ⁵
N8000-1500	N8000-1500 NETMAX Controller including DSP-2 Extension for a total of 1800 MIPS processing power, 12V. * This must be ordered as two (2) separate items: (1) N8000 120 V and (1) DSP-2. ⁵
DM-1	DM-1 NetMax Dante audio network module
TG7	Tour Grade 7 Power Amplifier ^{5,7}
TG5	Tour Grade 5 Power Amplifier ^{5,6}
RCM-28	OMNEO Network and DSP Module for Tour Grade Amplifiers
CPS2.12	CPS 2.12 Power Amplifier ^{5,6}
CPS4.10	CPS 4.10 Power Amplifier ^{5,6}
CP3000S	CP3000S 1600 W per channel Class-H power amplifier ^{5,6}
CP4000S	CP4000S 2100 W per channel Class-H power amplifier ^{5,7}
RCM-810	RCM-810 IRIS-Net remote control module for CPS Series amplifiers

- 5. Contact your sales representative for available voltage versions.
- 6. Maximum recommended two (2) elements in parallel for a 4 ohm load.
- 7. Maximum recommended three (3) elements in parallel for a 2.6 ohm load.

Ordering information

X1-212/90

X1 compact 2-way 1 x 12-inch 90° line array; black
Order number **X1-212/90**

Accessories

X12TC-GRID

Compact grid for up to 24 X1 or X2 tops, black
Order number **X12TC-GRID**

X12TE-GRID

Extended grid for up to 24 X1 or X2 tops, black
Order number **X12TE-GRID**

X12PU-BGK

Pull up bottom grid kit for X1/X2 tops, black
Order number **X12PU-BGK**

X12T-DOLLY

Dolly for six X1 or X2 tops, black
Order number **X12T-DOLLY**

Represented by:

Germany:

Bosch Sicherheitssysteme GmbH
Robert-Bosch-Ring 5
85630 Grasbrunn
Germany

Bosch Security Systems, Inc.
12000 Portland Avenue South
Burnsville MN 55337
USA

www.electrovoice.com